



1
OVERVIEW



2
CONTEXT
AND LOCAL
DISTINCTIVENESS

The relationship
between buildings
and spaces
determines the
success of a place to
live work and **visit**



3
PLACE MAKING
PRINCIPLES



4
IMPLEMENTATION



5
REFERENCES
AND GLOSSARY



The Council wants to see high quality and well designed buildings and places that lift the spirits.



1.1 Introduction

In 2012 the government introduced the National Planning Policy Framework (NPPF), which places good design at the heart of good town planning. Huntingdonshire District Council has produced this Design Guide to meet the requirements of the NPPF in supporting Local Plan policies and site allocations to ensure that good design is integral to all new development in the district.

The Design Guide is a manual to inform and inspire anyone with an interest in the design and development process for projects in Huntingdonshire. It will be a material consideration to be taken into account by the Council when determining planning proposals.

The Design Guide sets out important design principles which will help to create schemes that:

- are attractive and sit comfortably within a site and its setting
- make a positive contribution to the character of the surrounding area
- provide spaces which function well and are safe and secure to use
- conserve natural resources through building siting, design and construction

- are accessible to all potential users, including disabled people
- are practical to build, maintain and adapt
- are environmentally, socially and economically sustainable

The Design Guide is set out in three parts:

- Context and Local Distinctiveness
- Place making principles
- Implementation

The Design Guide has been created to be used as an electronic publication, and is not available as a printed document.

The introduction of the NPPF places good design at the heart of good town planning



Lawrence Court, Huntingdon



1.2 Purpose

The purpose of the Design Guide is to influence and raise the quality of design and layout of new development in Huntingdonshire, by providing practical advice to all those involved in the design and planning process on what the Council considers to be good, environmentally friendly and sensitive design. It does not differentiate between conservation areas and other areas, as it sets out key principles that should be applied to all development, wherever it may be located.

The Design Guide sets out design principles based on recognised best practice and explains key requirements that the Council will take into consideration when assessing planning proposals.

The Design Guide promotes locally distinctive design which respects and enhances the character of Huntingdonshire. The Council also values innovation and encourages contemporary approaches to new development where evidence arising from appraisal of the site and its context demonstrates that such an approach is appropriate.

B

H

←

The guidance is applicable to all new development, from large strategic developments to house extensions, from housing to commercial development.

Who should use this guide?

The Design Guide has been prepared for use by a range of different people involved in the development process. These include:

- Applicants for planning permission - seeking to make improvements to their homes or business premises.
- Councillors - in making decisions about development in the district.
- Developers and landowners - companies or individuals seeking to develop one or more buildings in the district.
- Local residents - who are concerned about or interested in development proposals in their neighbourhood.
- Professionals - local authority officers, and architects, designers and agents working on behalf of developers.

→



1.3 Objectives

The main objectives of this document are:

- To ensure a proper understanding of the local context and distinctive character of Huntingdonshire and to make clear the Council's design quality expectations, to create a strong sense of place and reinforce local identity.
- To ensure that all those involved have clear guidance on how to achieve attractive, high quality, well-designed and environmentally friendly development proposals which positively integrate with the surrounding landscape, townscape and infrastructure.
- To assist applicants for planning permission in understanding the design process, by providing information on the level of detail required to accompany an application, including supporting information to justify proposals and assess their impact.
- To assist all those involved in the decision making process in evaluating the quality of development proposals and ensuring that they satisfy the design requirements of the Council's planning policies.
- To demonstrate good design by providing examples of different types of well

designed developments that have been completed in and around Huntingdonshire.

The document does not propose a 'one size fits all' approach to design, and there are few specific requirements in the guide. However, it promotes a proper understanding of character and context so that the development of design solutions responds appropriately.

Proposals will be evaluated using the place making principles set out in this document and only schemes which follow these principles will be positively supported.

Proposals will not be supported where the applicant:

- Uses standard house types or 'off-the-peg' designs that are not sympathetic to local building characteristics and surroundings
- Fails to demonstrate how they have followed the guidance and principles set out in this document.
- Fails to take opportunities available for improving the character or quality of an area and the way it functions

- Lacks adequate supporting evidence to justify the design approach proposed.

B

H

←

→



1.4 Status of the Guide

The Design Guide will have the status of a Supplementary Planning Document (SPD) once it has been adopted by the Council. It has been prepared in accordance with the Planning and Compulsory Purchase Act 2004 and applicable regulations.

The SPD builds on the National Planning Policy Framework ([in particular chapter 7 – Requiring good design](#)), as well as the wide range of published guidance, in particular the [National Planning Practice Guidance \(NPPG\)](#), other national guidance such as the Manual for Streets and best practice guidance from organisations such as the Design Council CABI. The SPD supplements Local Plan policies which promote well-designed, sustainable development which protects and enhances the quality of the built and natural environment.

In addition the Council, neighbourhoods and developers may utilise a range of more detailed design tools to reinforce the principles contained within this guide. This includes area-wide public realm guidance, master plans and design codes, neighbourhood plans, conservation area character statements, site specific development briefs and urban design frameworks.

B

H

←

→



1.5 How to use the Design Guide

This Design Guide addresses all of the place making principles within development from land use through to site layout down to finer detailing of buildings and materials.

Part 1: Overview. The rest of this chapter seeks to define what good design is and identifies the most important best practice documents.

Part 2: Context and Local Distinctiveness. This chapter begins to define Huntingdonshire's context in terms of "local distinctiveness", and looks at both urban and rural character.

Part 3: Place Making Principles. This chapter sets out best practice principles that should be used to achieve successful outcomes through the design process.

Part 4: Implementation. This chapter includes a series of development scenarios and examples, demonstrating how an understanding of context and best practice guidance can be brought together to achieve exemplary development.

Part 5: Reference and Glossary. This chapter identifies a range of references that can help with the design process. It also defines some of the terms used in this guide.



1.6 Design Principles

To objectively assess the quality of a development proposal it is important to understand what good design means.

Good design is not just about what a place looks like, but how the place functions, how it is used, how people feel about it and how it adapts over time.

This creates a virtuous circle of a well designed place, where more people want to live, work and visit.

It is more often the relationship between buildings and the spaces between them that determines the success of a place.

Many of the ingredients that create attractive places may appear to be intangible and unquantifiable, but this Design Guide will help to unravel this mystery by establishing criteria by which the quality of any individual scheme can be assessed. It sets out a series of objective principles, 'the ingredients', to make successful places.

It concerns the connections between people and places, movement and urban form, nature and the built fabric.

Good urban design is a key to creating sustainable developments and the conditions for a flourishing economic life. Good urban design can help create lively places with distinctive character; streets and public spaces that are safe, accessible, inclusive, pleasant to use and human in scale; and places that inspire because of the imagination and sensitivity included in their design.

This Design Guide sets out to create those conditions. It does not attempt to define a single blueprint for good design. Rather, as an aid to understanding, it describes some of the objectives of urban design. These relate to how people use buildings and public space, and what they feel about the places they live and work in, and visit. The objectives are not unique to this guide, they have been tried and tested in other places.



Church Walk, St Neots

Good design is not just about what a place looks like



What is good design?

Design is the way we decide how we want things to be. Everything we make is designed by somebody. So the question is not whether we need or can afford design. It's whether design is good enough. In the built environment design is the key decision-making process. At the strategic level it creates the vision for places. At a more local level it describes how we want them to work, look and feel. Good design is not inevitable. It needs to be championed, invested in and worked at. All decision makers need to understand the importance of good design and how to achieve it.

There are three important principles that make it possible to recognise good design when we see it, regardless of style: robustness, efficiency and beauty.

They are variously described as robustness, or durability; usefulness, or efficiency; and beauty, or the ability to delight people. We must allow for creativity and beauty to surprise and delight us.

B

H

←

Attractive background buildings make up most of the places we love. While a mix of older buildings with new is often a sound starting point for great place making, many people also appreciate good contemporary architecture. Poor imitations of the styles of the past do not do justice to our own era's capacity for creativity and self-expression in design.

The Council has considered a range of best practice and policy, together with local issues to provide design guidance that is specific to Huntingdonshire.

Three useful best practice documents are:-

1. The Urban Design Compendium
2. By Design: Better Places to Live
3. The Concise Townscape

The following pages highlight the key elements of good urban, including The Urban Design Compendium and The Concise Townscape.



The Quay - St Ives

→



Urban Design Compendium

Good design draws together the many strands of place-making, sustainability, social equity and economic viability into the creation of places of beauty, which function well and have a distinct identity.

The Urban Design Compendium identifies seven key aspects of good design:

Create places for people. Places that are well used and well loved, safe, comfortable, varied and attractive, and are clear about the extent of the public and private realms.

Enrich the existing. New development should enrich the qualities of existing places, with distinctive responses that complement its setting, respect the grain of the area and acknowledge local character.

B

Make connections. Being easy to access, inclusive and permeable, as well as being integrated, physically and visually, with the surroundings.

H

←

Work with the landscape. Striking a balance

between the natural and man-made environments, using each site's intrinsic resources with care.

Mix uses and forms. Providing stimulating, enjoyable and convenient places for a variety of demands from a range of users at different times of the day.

Manage the investment. With an economic heart that will ensure that it is well managed and maintained, which helps secure the vitality and viability of the communities in which they sit and the infrastructure that serves those communities.

Design for change. Flexible enough to respond to future changes in use, lifestyle and demography.

A well designed place will combine functionality (does it work?), firmness (will it last?) and delight (does it look good?).

Good Design will respect context and will normally be in accordance with the planned aspirations of the local community. To secure good design, discussions with the planning authority and local community need to start

early, at the concept stage and carry on through pre-application discussions.

Volume 2 of the compendium provides practical guidance on the steps that can be taken to improve the quality of a place.





The Concise Townscape: Gordon Cullen

Gordon Cullen’s book, first published in 1961, talked about the spaces between buildings, moving on from the architecture of the individual building and looking at ‘the elements that go to create an environment: buildings, trees, nature, water, traffic, advertisements and so on, and to weave them together in such a way that drama is released.’

He made the comment that it is almost entirely through sight that the environment is understood, how the environment creates an emotional reaction, and there are three ways in which this happens.

1. Optics or ‘serial vision’

This is all about the existing view and the emerging view. As you walk through a town or village, what you see changes as you walk around a corner or down a side street or alleyway.



2. Place or ‘here and there’

This point relates to going to a place, entering a place and being in the place, about the here and the there. Some of the greatest townscapes have a HERE and a THERE.

3. Content or ‘this and that’

This relates to the fabric, colour, texture, scale, style, character and uniqueness of a place.

The aim is to join these three elements together to create a well-designed place.

His book is full of examples of how these three elements are seen in the real world and he used wonderful expressions to describe what you see in a townscape. He chose the small village of Buckland in Northumberland as an example where these elements could be found in their ideal location.

Cullen’s analysis of townscape components is applicable for today’s creation of place making and public realm.

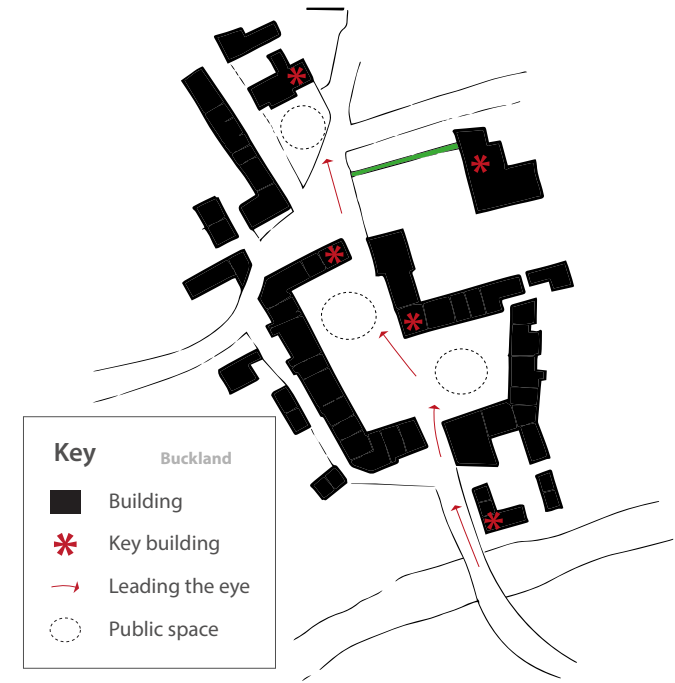
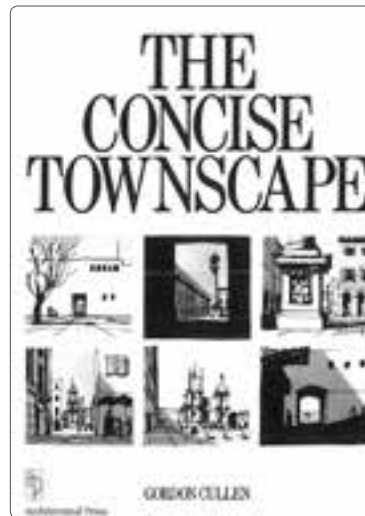



Other Components of Good Design

The main components of building form that will need to be considered include building on the foundation of character, context, urban structure and urban grain. Other elements for analysis are:

Density and mix. This influences the intensity of development, and the effect that it will have on both neighbours and the wider area. Will the proposals complement the surroundings?

Scale and height. The size of the building in relation to its surroundings, or the size of the building and its details, particularly in relation to the size of a person - is it human in scale?

Height is an important component of the impact of the development on views, vistas and skylines, all important parts of the public realm.

Scale and massing. The combined effect of the arrangement, volume and shape of a building or group of buildings in relation to other buildings and spaces. Will the proposals be coherent in context?

Appearance - Materials. The texture, colour, pattern and durability of materials and how they are used. How do they relate to their

neighbours, the local environment and the culture of the place?

Appearance - Details. Do the proposals show the craftsmanship, building techniques, decoration, and style of a building. Can the choice of building material and approach be understood?

B

H

←

→

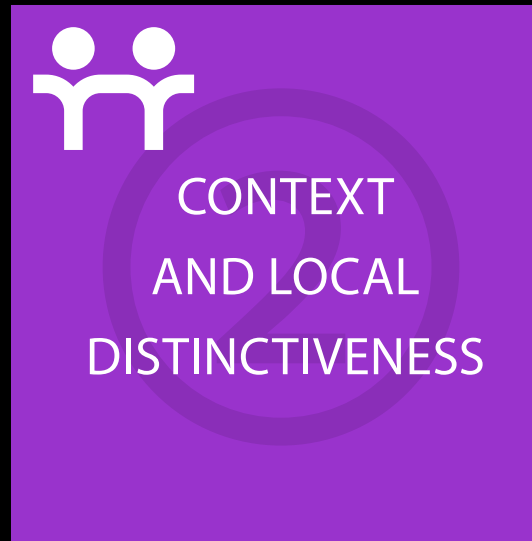

The positive features
of a place and its
people contribute to
its special character
and sense of identity.



2.1 Context and Local Distinctiveness

'Local Distinctiveness' essentially encompasses physical, social and economic characteristics of a place and the interaction of people with those characteristics.'

Destinations and Local Distinctiveness, July 2003

The positive features of a place and its people contribute to its special character and sense of identity.

These features include landscape, building traditions and materials, patterns of local life, and other factors that make one place different from another. The best places are memorable with a character which people can appreciate easily.

Many of the places which we now think of as being pleasantly distinctive grew naturally in response to local circumstances.

Where such distinctiveness is ignored, new development may reflect only the marketing policies or corporate identities of national and international companies, the standard practices and products of the building industry, or the latest fashions among design professionals.



Development that responds sensitively to the site and its setting, by contrast, is likely to create a place that is valued and pleasing to the eye.

A common criticism of development over recent decades is that many new homes could be 'anywhere', that there is nothing locally distinctive about them, and that they are not rooted in the local landscape and townscape.

We need to address this concern when assessing the quality of new development in Huntingdonshire.

All applications for new development in Huntingdonshire must demonstrate a firm understanding of how the site sits in its context. This includes common elements such as building types, scale, massing, architecture and materials as well as elements that comprise a place such as streets, open spaces and landscaping.

Over the following pages we set out the picture of Huntingdonshire, looking at the morphology of the towns and villages, and look at how some of the places in these towns and villages work as great places.

There is no reason why character and innovation should not go together. New and old buildings can coexist happily without disguising each other, if the design of the new is a response to place making principles.





2.2 Huntingdonshire in Context

Huntingdonshire’s settlements vary in terms of scale, character and local distinctiveness. They are shown on Map 2.2.1

The largest settlements are the market towns of St Neots, Huntingdon, St Ives and the smaller town of Ramsey.

Historically the three larger towns were agricultural centres developed along the Great Ouse river valley and further developed due to their position on national and regional transport routes. Development since the middle of the 20th Century has included large urban residential and industrial estates extending into the surrounding countryside, sometimes incorporating villages into their urban areas.

A number of large villages remain, such as Yaxley, Brampton and Sawtry. These villages typically retain much of their historic character in the centre, but also incorporate significant modern housing developments at their peripheries.

(B)

Small villages are distributed fairly evenly throughout the district, although the Fen villages have a much sparser settlement pattern.

(H)

(←)

Isolated hamlets are scattered across the district developed usually along roads in linear form.

Further Reading:
Huntingdonshire Landscape and Townscape Assessment SPD (2007)
Cambridgeshire Landscape Assessment

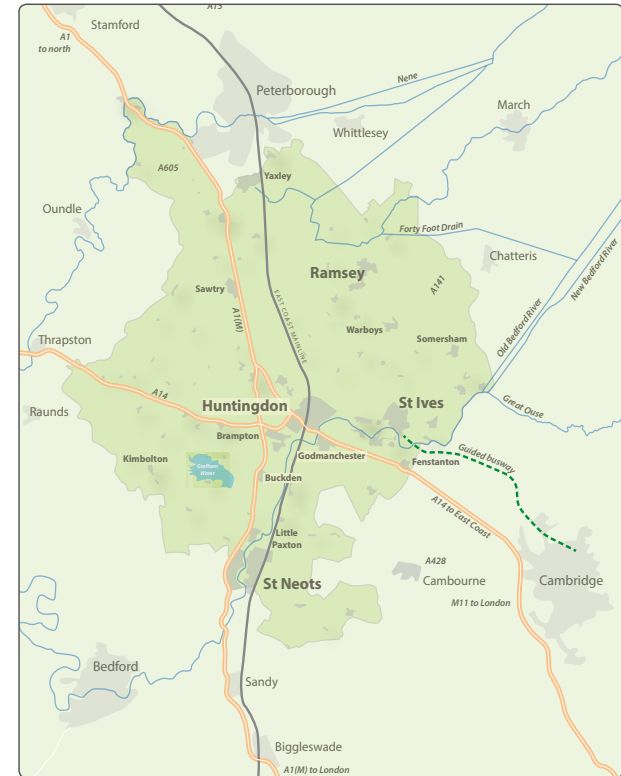

Figure 2.2.1 Map showing Huntingdonshire in context

(→)



Existing Settlement Pattern

In this section we identify some of the key characteristics of the market towns and villages of Huntingdonshire. These characteristics constitute the feel and essence of these places and provide important clues to guide future development.

Market Towns

Key characteristics of market towns are:

- A traditional spatial organisation based around a focal market square providing a setting for iconic buildings such as ancient churches and town halls, creating a historic core with surrounding parkland or common land
- A predominantly asymmetrical settlement pattern, typically imposed by riverside locations
- A compact urban fabric with limited or no building set-backs along streets in the town centre
- Generally towns have a compact pedestrian town centre core with a central 'high street' and fine grain network bounded by 2-3

storey buildings of a variety of types, ages and styles

- Good regional connectivity with access to A-roads and the railway
- A town centre surrounded by extensive areas of sub-urban post war housing
- Large areas of peripheral industrial development close to main roads and railway lines, often isolated from the town centre core
- Multiple development and activity areas
- Large areas of peripheral industrial development close to main roads and railway lines, often isolated from the town centre core
- Multiple development and activity areas

The following maps show how the major towns have been arranged in terms of land use and routes. Figure ground plans are also shown. These plans show the variety in the mass of buildings and how they are arranged.





St Neots

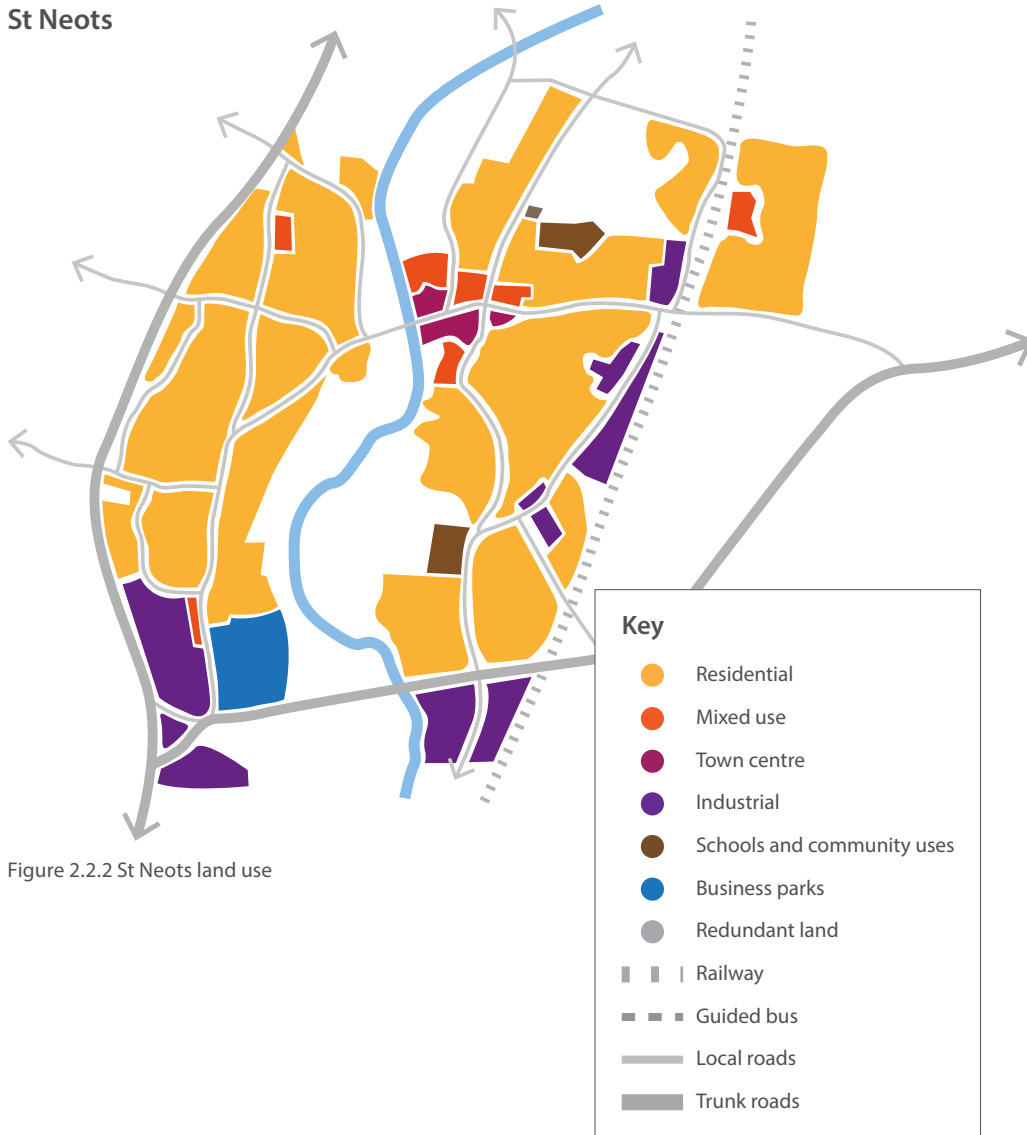

Figure 2.2.2 St Neots land use



Figure 2.2.3 St Neots figure ground plan



Huntingdon



Figure 2.2.4 Huntingdon land use plan

Ramsey

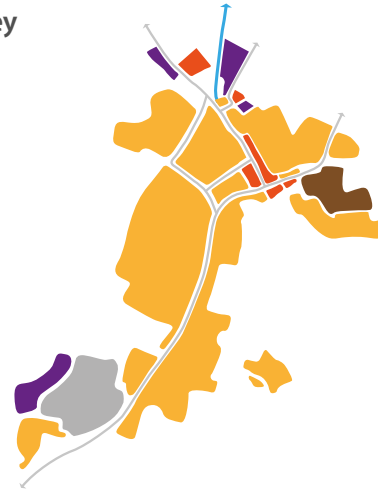

Figure 2.2.6 Ramsey land use plan

St Ives

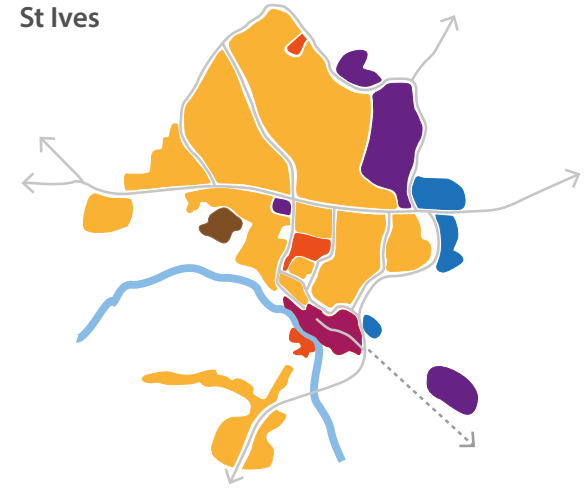

Figure 2.2.8 St Ives land use plan



Figure 2.2.5 Huntingdon figure ground plan



Figure 2.2.7 Ramsey figure ground plan



Figure 2.2.9 St Ives figure ground plan

B

H

←

→



Large Villages

Key characteristics of Huntingdonshire’s larger villages are:

- A traditional layout with continuous built form along and around a linear high street, creating a historic core where most of the economic and social activity takes place
- The historic core usually has a strong locally distinctive heart
- Large areas of cul de sac type suburban development beyond the historic core, mostly built between 1960 and 1990
- An increasing number of smaller infill developments now more commonplace than the previously more widespread suburban development

- A greater connection to the ‘country side’ and open space than with the market towns
- Pressure on some village facilities such as pubs and smaller shops, with some closing
- Some employment areas within and on the edge of these villages

This example of Somersham illustrates the morphology of a typical large village in Huntingdonshire.

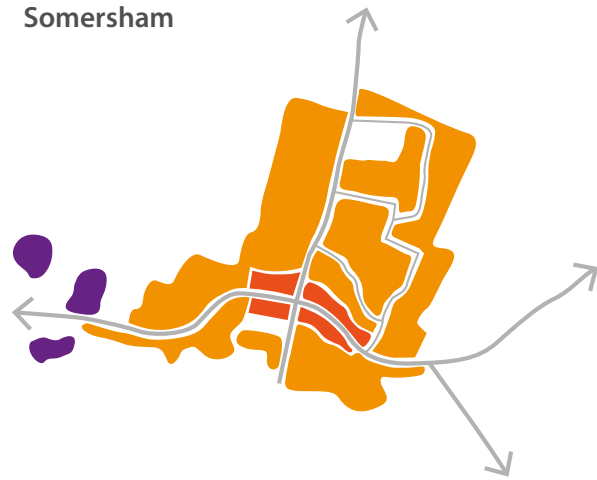

Figure 2.2.11 Somersham land use map



Figure 2.2.10 Somersham village centre figure ground plan



Figure 2.2.12 Somersham figure ground plan



Small Villages

Key characteristics of Huntingdonshire's smaller villages are:

- Traditional linear spine development organised by a primary high street with a quick transition to secondary and tertiary streets leading from it
- Singular development focus constituting of village green, church, school and local shops or pubs
- Limited or no setbacks or defensible space along High Street
- Continuous ribbon development frontage along 'high street' with buildings typically between 1 and 2 storeys
- Use of traditional building materials and building types
- Typically street corridors are narrow and defined by mature trees with large setbacks for residential buildings
- Limited national and regional connectivity with access primarily from B roads and limited bus services

- Immediate proximity to countryside and farm land with increased sensitivity on impact of buildings on the landscape
- Traditional buildings such as barns sitting in the surrounding countryside
- Limited facilities and no real employment other than farming and home/office working

The example shown is of Hemingford Abbots



Hemingford Abbots

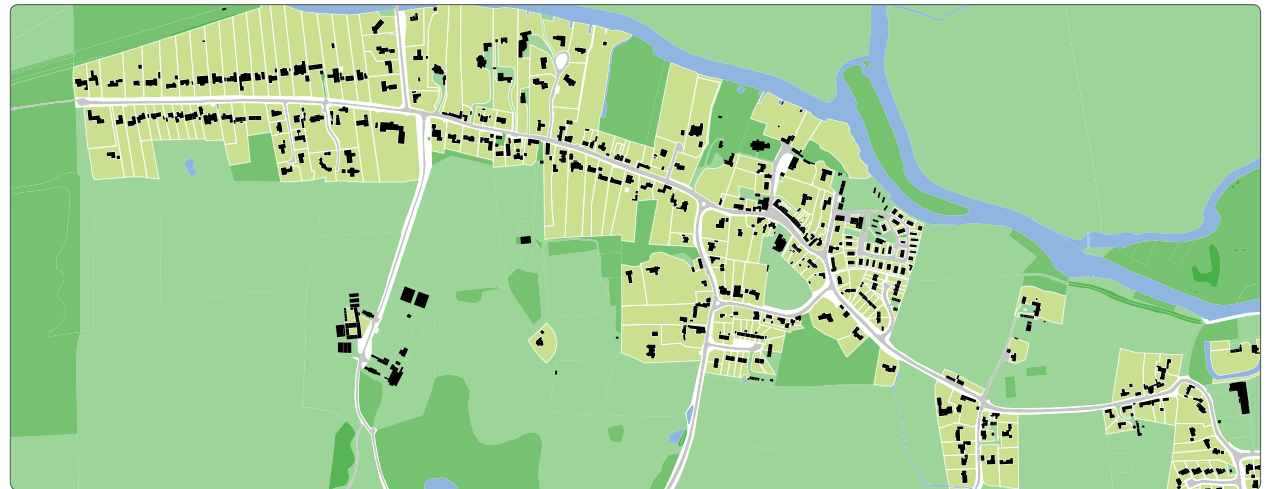

Figure 2.2.13 Hemingford Abbots



Great Gidding is another example of a linear village, strung out along a road with a view to the parish church.

Other villages demonstrate the rarer 'ring village' typology, such as Woodhurst.



New courtyard development in Great Gidding



View towards Great Gidding church

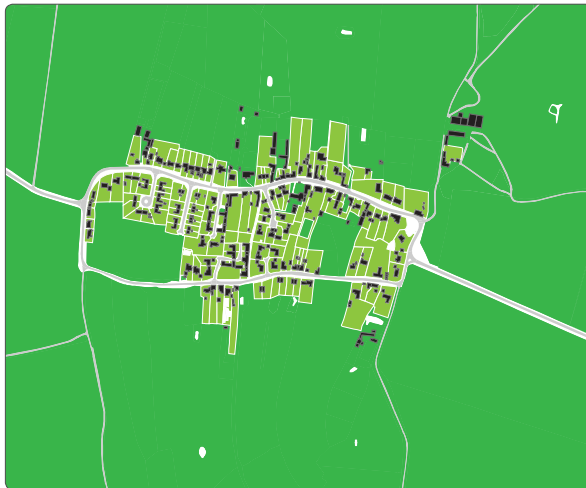

Figure 2.2.14 Woodhurst



Figure 2.2.15 Great Gidding





2.3 Development Strategy

All new development in Huntingdonshire needs to be of the highest standards of design, based upon a thorough understanding of the site and its context.

The Local Plan sets out the overarching development strategy for Huntingdonshire to 2036. It seeks to concentrate development in locations which provide, or have the realistic potential to provide, the greatest access to services and facilities as well as encouraging limited development for rural communities to support social and economic sustainability.

The Local Plan promotes sustainable development including economic growth that will safeguard and enhance green infrastructure, the district’s landscape and townscape

All applications for development must comply with the Local Plan and this guide should be read in conjunction with it.





2.4 Strategic Connections

Huntingdonshire is served by regional rail and road networks with the main settlements connected by road to nearby commercial centres such as Cambridge, Peterborough and Bedford.

The A1(M) provides a north-south link to London and the north of England, while the A428, A14 and A605 via A47 connect the East Anglia ports and the Midlands. Plans to reroute the A14 around Huntingdonshire are due to be implemented.

There are two mainline railway stations at Huntingdon and St Neots, which provide connections to Peterborough, London Kings Cross, and beyond.

Recent transport investment includes the Cambridgeshire guided bus way which provides a dedicated bus route between Cambridge and St. Ives and further links to Huntingdon and Peterborough. The bus way corridor also includes a long-distance cycle route.

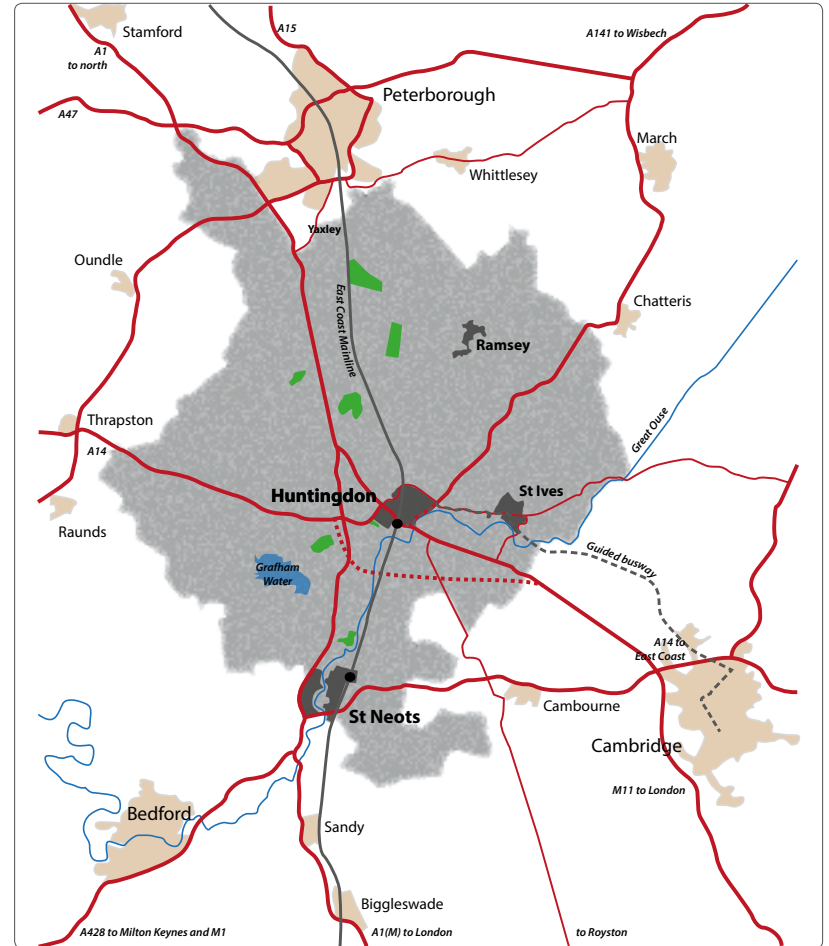

Figure 2.4.1 Strategic connections





2.5 Landscape Character Areas

The geology and topography of Huntingdonshire is described in detail in the [Landscape and Townscape Assessment SPD](#). This defines nine landscape character areas within Huntingdonshire. These are:

1. The Fens
2. Fen Margin
3. Central Claylands
4. Ouse Valley
5. South East Claylands
6. Northern Wolds
7. Grafham Water
8. Southern Wolds
9. Nene Valley

The design of new development must have regard to this landscape context.

The Great Fen is a landscape scale project to restore over 3,700 ha of farmland to traditional Fen, with huge benefits for biodiversity and access to the countryside.

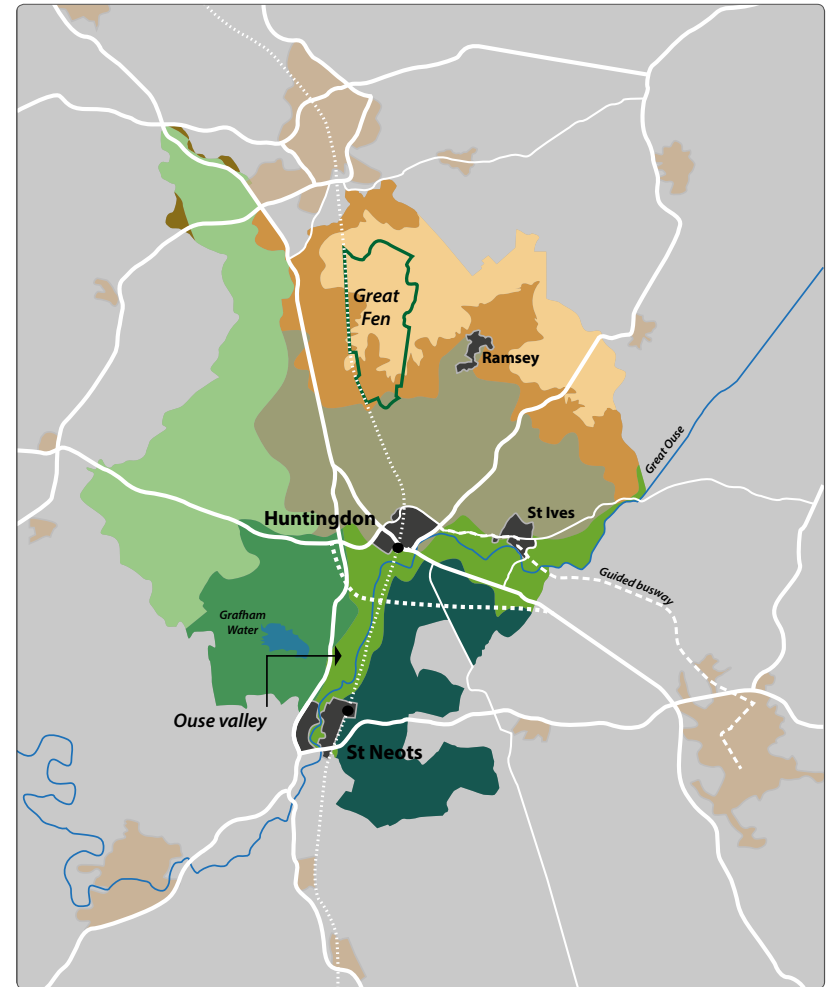
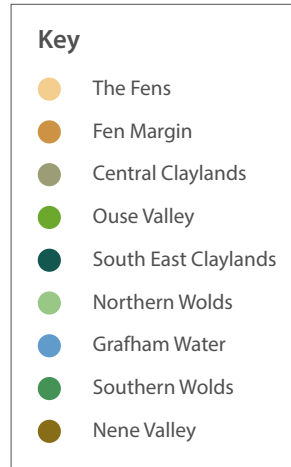

Figure 2.5.1 Landscape character areas



2.6 The Nature of Public Space

Traditional settlements are made up of various elements that together create a sequence of legible and memorable places. These places shape our experience of a town or village. We generally remember places and spaces rather than individual buildings, and the character of the whole is greater than the sum of its parts.

There are different types of places and spaces, such as market squares, greens or junctions. Some successful examples have been identified and assessed in the next section.



Market Square, St Neots

We generally remember places and spaces rather than individual buildings

- 2.1
- 2.2
- 2.3
- 2.4
- 2.5
- 2.6**
- 2.7





Market Square - St Neots

This is the main public space in St Neots. It is used for markets two days a week, and as a car park on the other days, with part of the space used as a pedestrianised sitting out area to eat and drink. The space is very well enclosed by active terraces of mostly three storey buildings, dating from the 19th century and earlier. These buildings are used by a combination of shops, offices and cafes/pubs. Trees are planted along one side of this space.

It is a very good example of an active public space in the heart of a town, although the main road that runs to the north of the site can be busy however, the main flaw is that the river, which flows close by, is not as connected to this space as it should be.

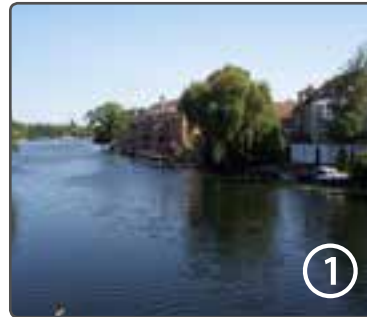

View from the bridge



Market Square



Hen Brook

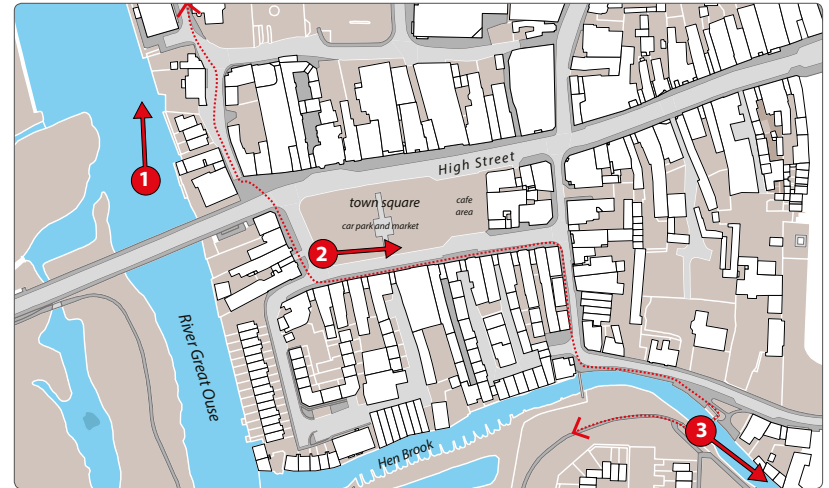

Location of 3 photographs (right) around the Market Square (below), St Neots



Market Square, St Neots



The Quay - St Ives

This public space shows how a simple river frontage can create an attractive place which attracts many visitors. It is not a large space, but it works and is a destination. The key elements to making this space successful include:-

1. places to sit and relax
2. the river – something to look at
3. interesting architecture of adjacent buildings such as the bridge

4. attractive and appropriately scaled buildings enclosing the space on the landward side
5. lots of safe pedestrian access with limited vehicle traffic

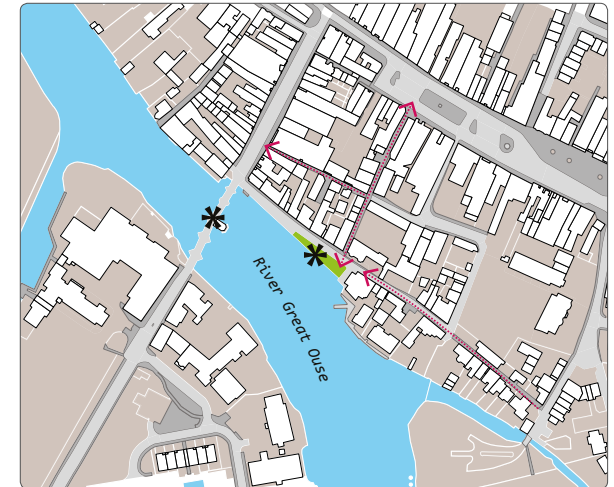
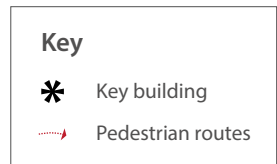

The Quay9 - St Ives





Warner Park - St Ives

This park shows how buildings and tree planting can create and enclose a space. The scale, massing and design of the buildings all contribute to making the space successful.

The older buildings running along the western edge of the park have a more successful relationship with the park than the newer buildings on the south eastern, eastern, and northern edges because the newer buildings do not face onto the park and therefore do not fully maximise its benefits.



Key

- * Key building
- > Pedestrian routes



Warner Park from the south







Victoria Square - Huntingdon

This is a small space but the sense of enclosure created by the buildings is the key to its success. Seating and tree planting makes this space welcoming.

Direct and accessible pedestrian routes run through the centre of the area.

Key

-  Key building
-  Pedestrian routes



Focal building at the northern side



Victoria Square, Huntingdon

The sense of enclosure is the key to the success of Victoria Square





Honey Hill - Fenstanton

Honey Hill is an example of a series of small spaces, grass verges and tree planting that have a very pleasing impact on how a place is viewed. Colourful tree species and the attractive arrangement of buildings to provide vistas contribute to this areas success.

Key

- * Key building
- Pedestrian routes



Honey Hill, Fenstanton

Colourful tree species and attractive building arrangements contribute to this areas success





Village Green - Brampton

This example demonstrates how a traditional village green works, with plenty of mature trees and a generous amount of open space. Although not in the centre of the village, the location of the primary school adjacent to the green complements its role as a focal space and a heart for the village.



Village Green, Brampton





2.7 Architectural Character

Traditional Architecture

The towns and villages within Huntingdonshire contain many fine examples of vernacular architecture. The materials used vary depending on the age, location and type of the buildings.

Thatch and render construction is most commonly seen in older houses in the Claylands, with brick (both buff and red) in buildings from the 18th century onwards. Limestone is the traditional building material in the Nene Valley, and is also used mainly for churches and bridges throughout the district.



Great Gransden



Hilton



Sawtry



The towns and villages of Huntingdonshire contain many fine examples of vernacular architecture

- 2.1
- 2.2
- 2.3
- 2.4
- 2.5
- 2.6
- 2.7





Contemporary Architecture

Huntingdonshire was not affected by the major suburban growth of the 1920s and 1930s that happened in many of the larger and more industrialised towns and cities of England. Instead it saw rapid growth between the 1960s and 1980s with large residential estates developed in all the market towns. Most of these post war developments could be regarded as ‘anywhere’ places, lacking the sense of belonging that earlier development has.

There are now emerging examples around the country and elsewhere within Cambridgeshire that try to address this issue of how to make contemporary interpretations of traditional building forms. The most successful are often single dwellings or small infill developments. Larger scale residential development is where it has been most difficult to create a locally distinctive contemporary development.

For other building typologies, such as commercial buildings and community buildings, it is generally much easier to design buildings in a contemporary way that also reflects their local setting.

The design of new development in Huntingdonshire must draw from these traditional building forms found within the district, with particular reference to locally distinctive built form, scale, proportions, details and materials.

Contemporary interpretations of local building forms will be encouraged and welcomed, with particular emphasis on using more natural light in the design of buildings, more articulation to the elevations and the use of locally distinctive materials.

B**H****←**



PLACE MAKING PRINCIPLES

These principles, when applied, will make well designed places the norm rather than the exception.



3.1 Place Making Principles

This chapter of the Design Guide sets out important place making principles that should be used to create attractive developments throughout Huntingdonshire.

These principles, when applied, will make well designed places the norm rather than the exception.

These principles can be applied to all forms of development, although some details are specifically applicable to certain types of development.

The guidance is structured as follows:

- 3.1 Place Making Principles
- 3.2 Land Use and Density
- 3.3 Place Making and Hierarchy of Movement
- 3.4 Urban Structure and the Development Block
- 3.5 Parking and Servicing
- 3.6 Landscape and Public Realm
- 3.7 Building Form
- 3.8 Building Detailing



Primrose Lane, Huntingdon





3.2 Land Use and Density

When assessing proposals the right land use and density is essential. The optimum type of development is when a mix of uses is proposed.

A core planning principle in the NPPF is to “promote mixed use developments, and encourage multiple benefits from the use of land in urban and rural areas” (NPPF, 2012, paragraph 17).

Mixed use development can include a variety of activities such as shops, offices and community facilities, as well as local amenities such as parks or schools. Such development is best located within easy walking distances of homes and public transport connections.

What mixed use does not mean in this context is the provision of a variety of uses that do not relate well to each other or are separate from each other, not creating attractive arrangements of mixed use and other buildings, nor taking the opportunities available to create attractive streetscenes and overlooked shared spaces and routes. Paragraph 17 of the NPPF should be read with paragraph 56.

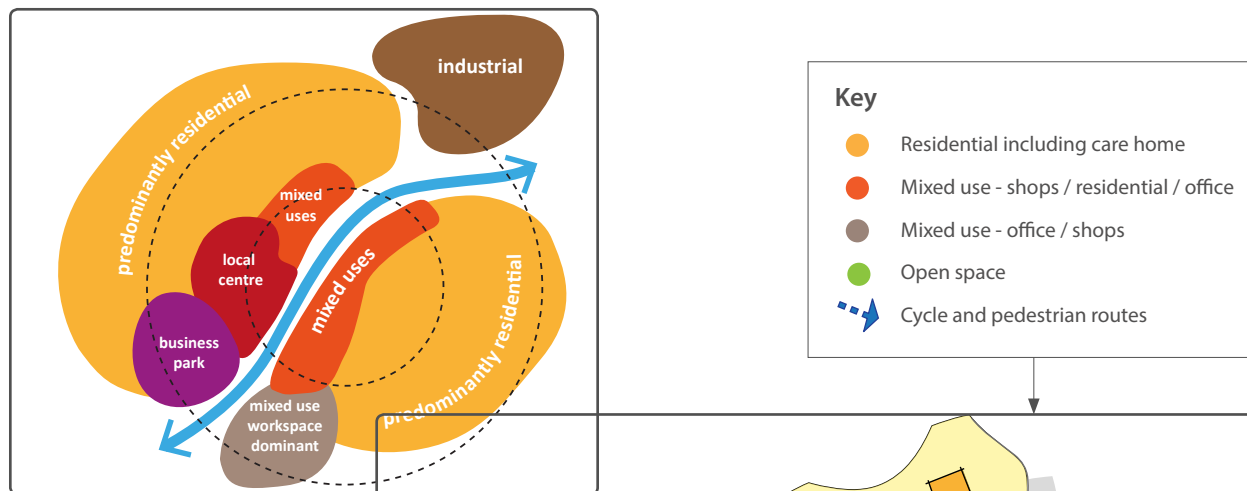

Figure 3.2.1 Mixing uses over a wider area



Figure 3.2.2 How to mix uses well in a town centre or edge of town centre location





In existing town centres and new local and neighbourhood centres, such horizontal integration (houses next to shops etc.) and vertical integration (flats and offices above shops etc) is vital in ensuring that busy and active places are created.

The plan of part of St Ives below shows varied land uses on the ground floor.

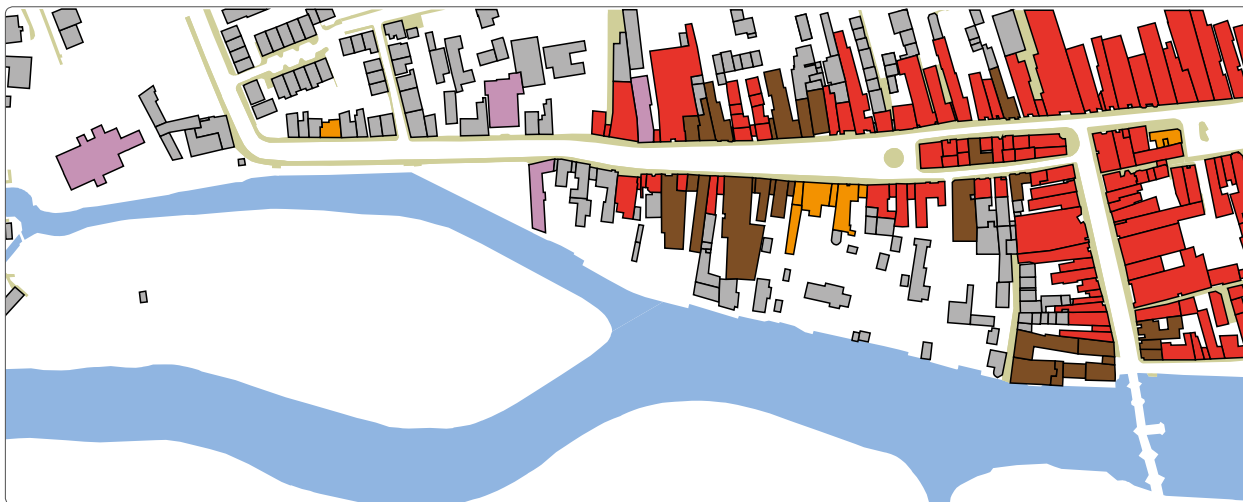
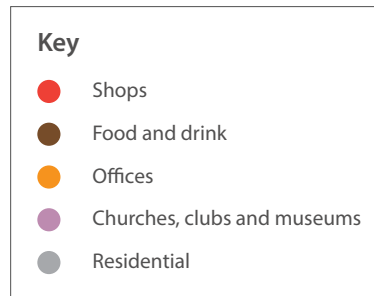

Map 3.2.1 This map of the centre of St Ives shows the variety of building uses that exist in the centre of the town



High Street, Huntingdon



It is vital to ensure that busy and active places are created



Development can be mixed either horizontally (with well designed buildings of different uses adjacent to each other) or vertically (different uses within the same building) or can be clustered as well designed groups of buildings. For example: a mix of flats or offices above shops or a supermarket, or groupings of restaurants, community or other leisure uses within town or new local centres.

A combination of different land uses will add variety and diversity to an area, contributing to its sense of place and community.

It is also important to integrate a wide variety of housing tenures (rented, owned or shared ownership) and typology (apartments of varying sizes, starter homes, and larger family houses) within any new development, to help to achieve a broad demographic base within a community.

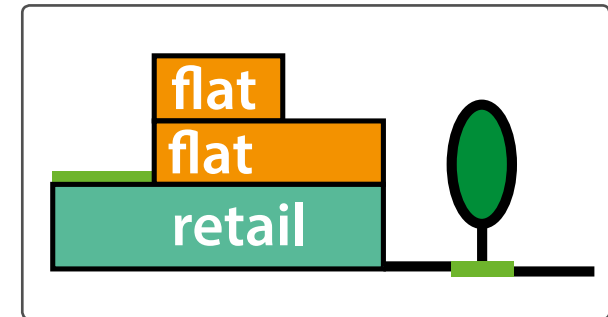
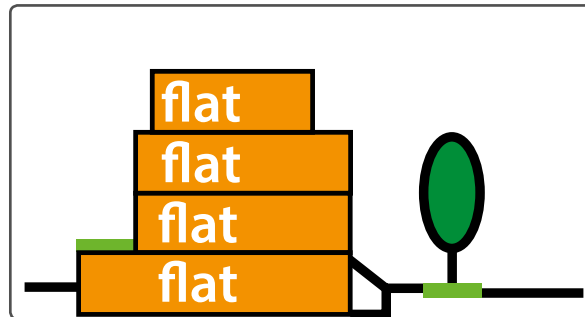
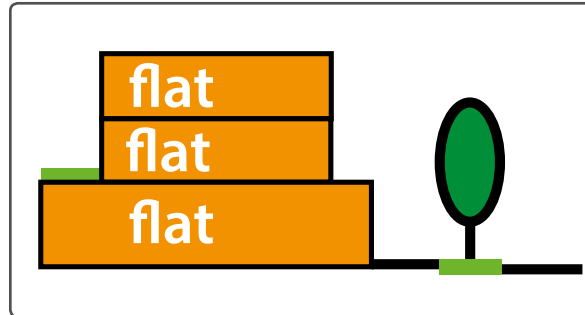



Density

Density means the intensity of land use, that is, how much development is built on a site or area. Within Huntingdonshire the highest building densities are typically located at the centres of the market towns and larger villages, while rural areas are typically built to lower densities.

Higher density residential developments can locate greater numbers of people within the 5min/400m and 10mins/800m walking distances of local centres, improving the viability of services located there (see p45).

From a design perspective, proximity to good public transport, local facilities and key amenities generally support development at higher densities. Higher density offers the potential for more sustainable development, by minimising land and energy consumption and the need for travel by private car.

High densities do not equate to high-rise buildings or a poor urban quality of life. The centres of many of our most attractive towns and villages are built at relatively high densities.

High density development must be of a human scale, be of appropriate massing, and

incorporate landscaped amenity space to create an environment with a high quality of life.

Density must reflect its context, be it town or village, edge or centre. The figure below provides examples of various density ranges provided in the following pages.

The figure right shows how very different forms – a tower, terrace or courtyard layout can be built at the same density. In this case 75dph with very different results in terms of mix of units and quality of public and private space provided.

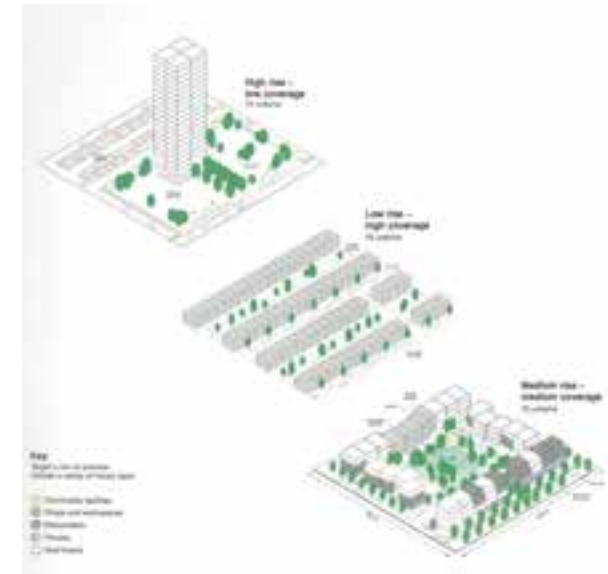

Any proposals for large scale development will be expected to include a wide range of densities and associated character areas.



Figure 3.2.3 - Transition of density from high to low

B

H

←

→



How can we measure density?

There are many different ways of measuring density, each of which provides different information. Describing density by habitable rooms or people per hectare can give an indication of resident populations and is a more accurate calculation of population capacity within mixed use areas. However, these terms are not widely used by central government or councils; the definition of density commonly used by local authorities is expressed as dwellings per hectare (DPH).

The area used to calculate density is generally the net site area (includes access roads within the site, private gardens, car parking areas, incidental open spaces and landscape and children’s play areas).

Gross site areas (including major distributor roads, local shops, schools, community facilities, employment areas, open spaces serving a wider area and significant landscape buffer strips) are commonly less used.

B

Both net and gross densities are calculated using the basic formula: the number of dwellings divided by the area of land that they occupy.

H

←

dph
dwellings
per hectare



hrh
habitable
rooms per
hectare



pph
people per
hectare



Figure 3.2.4 - Different approaches to measuring site density

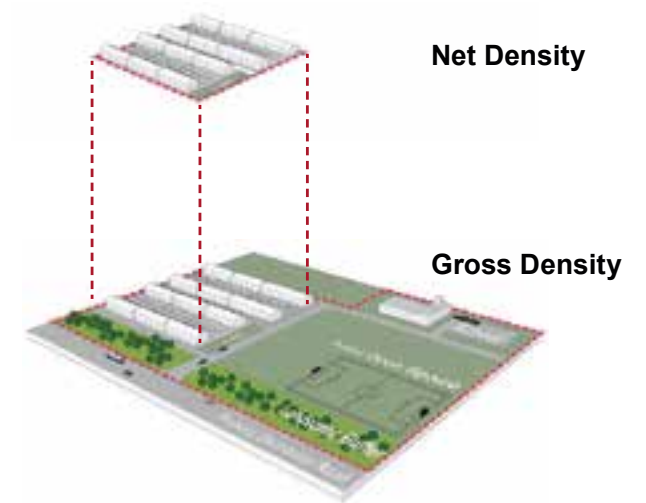

Figure 3.2.5 - Areas of Net and Gross Density

→



High Density

In Huntingdonshire, the type of development found in the centres of all the towns and most of the villages can be described as high density.

These areas tend to have been mostly built by the 19th century and usually much earlier, and have a high proportion of dwellings joined together in terraced form. They were generally not built with vehicle parking in mind, but many of the roads were wider and so, in the 20th century, have managed to accommodate car parking as car ownership has increased over the decades.

These high density areas often provide a high quality and attractive environment, with desirable buildings and interesting spaces, and good character.

Central government has encouraged development at higher densities in recent years. It is important that such development incorporates high quality public realm and a mix of parking solutions to ensure they form attractive places to live.



St Ives



Temple Close, Huntingdon



Former ATS site, St Neots



Bydand Lane, Little Paxton

B

H

←

→



Medium Density

Within Huntingdonshire, suburban development within towns and villages is often characterised by medium density. These areas tend to consist of short terraces, semi-detached and detached dwelling with often driveways and garages to deal with car parking. Some of the post war estates lack a sense of local identity and character.

A notable proportion of new development in the District is likely to be medium density and it is therefore important that they are well designed and create character areas across the site.

Well designed new medium density development is an important element in the mix that helps to create places of character.



Bydand Lane, Little Paxton



Fox Brook, Loves Farm



St Neots





Low Density

Within Huntingdonshire, the type of housing found in the edges of some of the towns and villages within the district, as well as some earlier suburbs that have been ‘leapfrogged’ by later development can be described as low density. These lower density areas tend to consist of detached dwellings as well as farmyard type development.

These areas have been built up over the centuries, although recently there have been fewer examples of large areas of low density housing being constructed, indeed some of the more desirable lower density areas have seen more building in the form of infill development, and this has sometimes affected the character of an existing area.

Lower density areas will usually consist of individually designed and built houses in a street or lane rather than any larger scale housing development, and consist of buildings of varying ages.

Low density development should also be encouraged if the context of the site and the opportunities and constraints lead to this conclusion.



Hemingford Abbots



Scotts Close, Hilton



Leighton Bromswold, Cambridgehire

Lower density areas in villages more often consist of detached dwellings or farmyard type development





3.3 Place Making and Hierarchy of Movement

In considering the potential for new development, it is important to study how a site relates to existing routes and the best ways to connect to surrounding places.

Making the right connections into and out of new development sites is a major component of 'place-making'. These connections are made by paths and streets. Streets make up the greater part of the public realm and street design impacts greatly on everyone's quality of life. Streets and paths also have an important relationship with the distribution of land uses, density and patterns of activity.

The following pages look at these aspects of place making, and at examples of different street types.

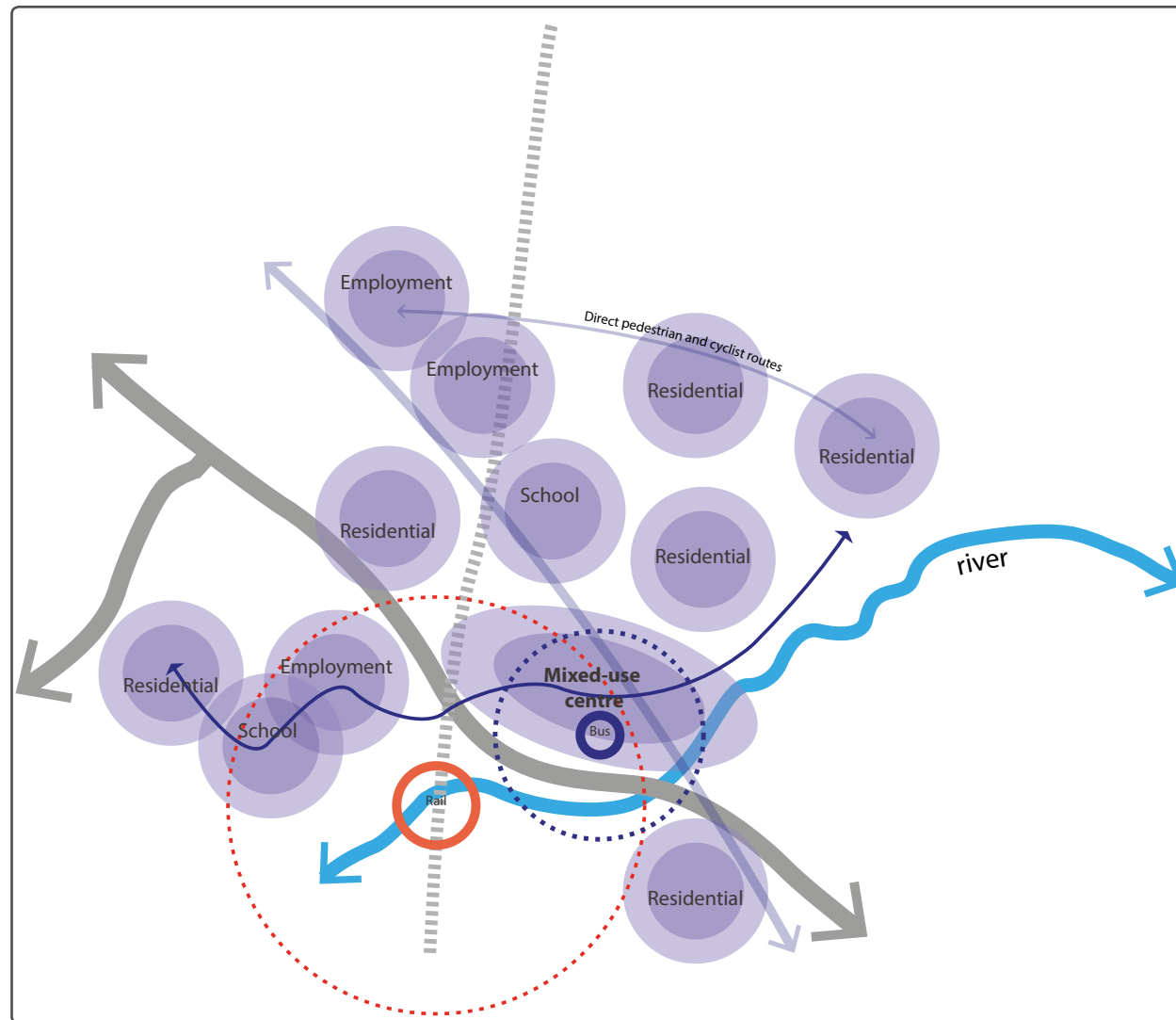

Figure 3.3.1 Diagram showing the connections between different areas of Huntingdon





Walkable Places

Successful places are created by making it easy to walk between and through, to the local services and facilities where people want to go.

Ideally new homes will be built to be within a walking distance of 400 metres (5 minutes walk) to bus stops and local green spaces and a distance of 800 metres (10 minutes walk) to local shops and primary schools and other areas of green amenity space.

Creating new walking routes and connecting to existing walking and cycling routes by the simplest and most direct way should be a major consideration and priority in all new developments in Huntingdonshire.

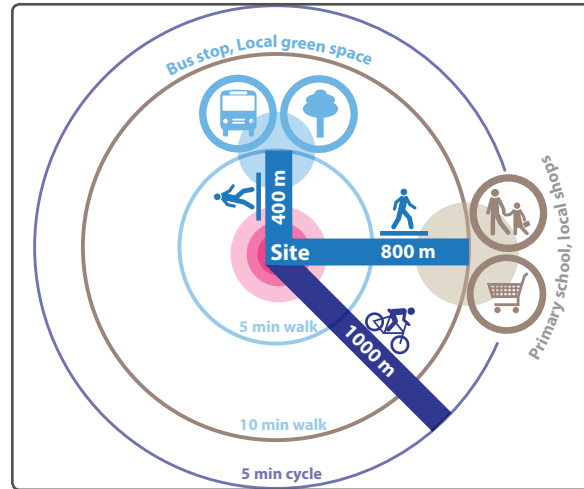

Figure 3.3.2 Travel distances for accessible neighbourhood



Walkable spaces - St Neots



Preserving existing pedestrian routes in a new development - Ely



Attractive pedestrian route adds character to this village - Offord Cluny



Permeability

An area with a comprehensive network of footpaths and cycle paths can be described as an area with good permeability.

A characteristic of development since 1945 has been a general lack of permeability, where many developments do not have good or convenient pedestrian and cycle linkages with their surroundings. Some developments have features that specifically prevented permeability.

New housing proposals should provide direct and attractive walking connections between

neighbouring streets and to local facilities such as community uses, schools, local centres and public transport facilities. The Council wants new developments to create permeable networks of connections within development sites as well as connecting to the wider locality, and to public footpath networks beyond.

When creating new links, barriers to vehicle movement should be kept to a minimum.

Gates should be avoided in new development, unless they can be designed as a focal point in locations where they can be kept open.



This is very poor. These two developments have been separated by a brick wall! - Bedford



Figure 3.3.3 Creating cul de sacs creates longer journeys to school and encourages driving



Figure 3.3.4 Creating direct footpath routes to the school encourages walking



Wayfinding and Legibility

A way of making walking and cycling easier is to ensure that routes are direct as well as memorable, and this can be achieved by 'way finding'.

Way finding can be achieved by including a range of "signposts" that assist someone to find their way around a network of routes. These signposts can include interesting buildings or other landmark elements. A clear network of paths or routes must be established to connect important places via memorable routes with minimal obstruction. This memory is what makes a route legible.



Creating a wide pedestrian route encourages use - Huntingdon



This alleyway leads to the river and is well used - St Ives



Connecting important places via memorable routes is an important element of town planning

St Neots, Cambridgeshire





Serial vision

A way of describing the way finding process is to think about the work of Gordon Cullen and his theory of serial vision. He described the idea of walking from one place to another providing a sequence of revelations in streets and buildings, the progress of travel illuminated by a series of sudden contrasts.

Subtle deviations in alignment and small variations in setback of buildings can have a disproportionately powerful effect of discovery and drama as you move through a town or village.

This is delivered through development that allows free movement from one place to another, movement to the enclosed space of a square or courtyard where people meet, and to the focal point where people go to, the place that says ‘this is the spot’.

This process can be described as the interplay between ‘here’ and ‘there’, and can be best described by looking at examples that demonstrate these features, such as a marker

sequence of focal buildings, landmarks and vistas.

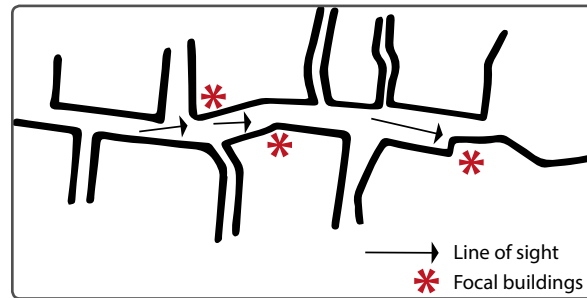

Figure 3.3.5 A marker sequence in an informal grid

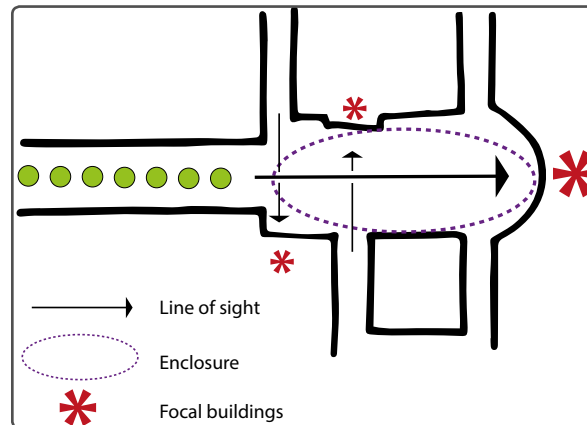

Figure 3.3.6 A marker sequence in a formal grid





Landmarks and Vistas

Landmarks act as a visual guide for people to navigate through places. It is important to include landmarks as markers within developments to ensure that places are recognisable, distinct and memorable. Buildings should be designed to respond to view corridors or reinforce views to existing landmarks with appropriate building massing and architectural treatment.

Designing new landmark features for development sites offers some great creative opportunities, particularly if the richness and diversity of the shapes, colours and forms that pepper the historic environment of a town or village are used for inspiration.

‘Landmarks’ do not have to be huge; a modestly sized piece of public art or even a tree can have landmark qualities if it helps us to navigate around and understand how a place works and fits together. But landmarks should also be innovative and interesting.



This pink rendered building provides an interesting view - Godmanchester



An interesting building provides the vista along this avenue - St Neots



Views to the church have been opened up in this redevelopment - St Ives



This view opens up as you walk along Church Walk - St Neots





Buildings should be designed to reinforce views to existing landmarks through appropriate scale and mass

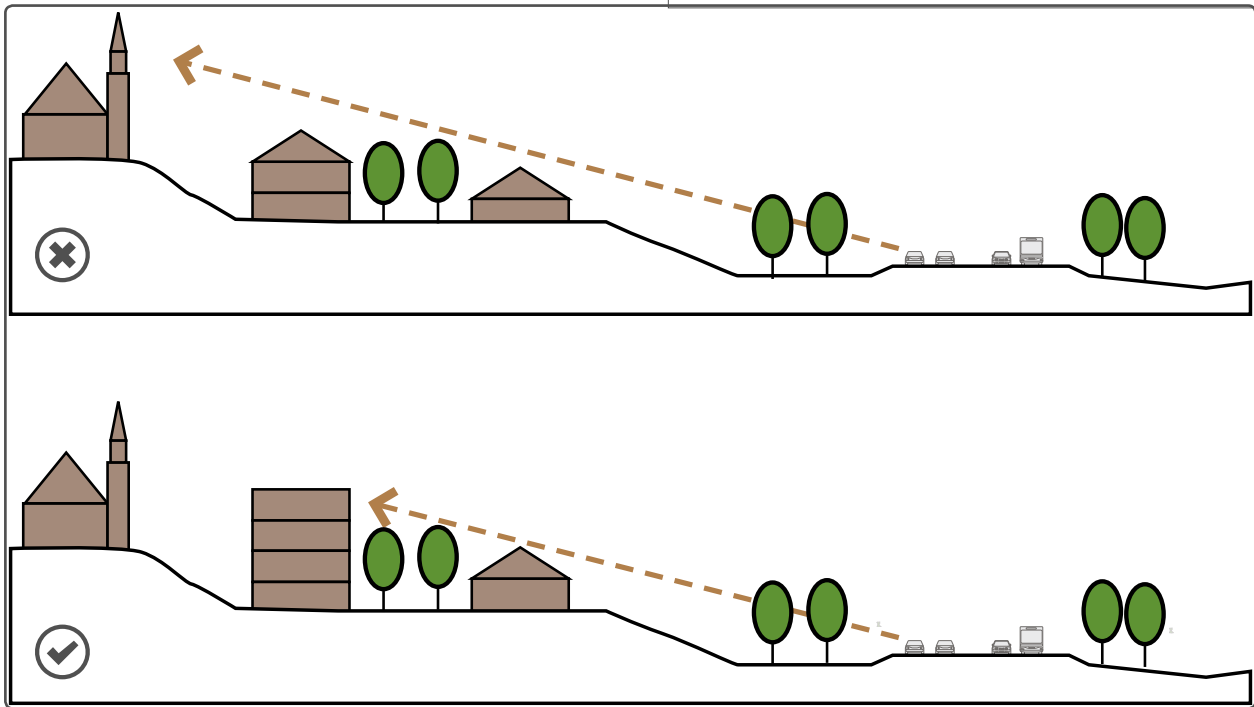

Figure 3.3.7 How to protect views to existing landmarks when assessing new development proposals

- (B)
- (H)
- (←)



Upton, Northamptonshire





Hierarchy of Movement

Street design is a fundamental aspect of place making. Streets must meet the technical requirements as set out in Manual for Streets and Manual for Streets 2 with respect to turning radii and visibility splays. However the underlying principle is that the concept of a street as a ‘space’ will take priority over engineering considerations.

Streets must be considered as spaces for use by all, not just the motorist. It is essential that the design of new development should include streets that incorporate the needs of pedestrians, cyclists and public transport users.

This will be assisted through the identification of a movement hierarchy, with different streets having a specific character linked to their role and function.

An appropriate street hierarchy should be created, with primary, secondary and tertiary

streets being identified in proportion to the scale of development.

Streets for primary vehicular movement should have clearly defined pavements and cycle lanes. In quieter places, low-speed streets (below 20mph) should make provision to share the space between pedestrians, bicycles and cars.

Home zone streets and shared space streets should also be considered as an integral part of any new development.

Consider first:

- Pedestrians
- Cyclists
- Public transport users
- Specialist service vehicles (eg emergency vehicles and bin wagons)

Consider last:

- Other motor traffic

For further reading use the following weblink:

Manual for Streets p28 table 3.2

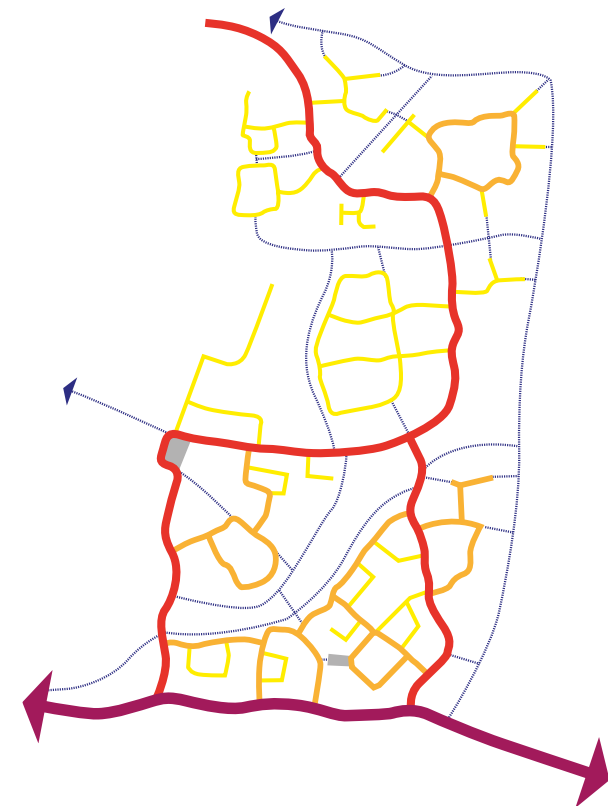
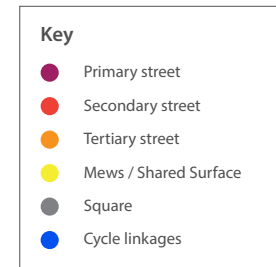

Figure 3.3.8 Hierarchy of movement, Loves Farm





Road Networks

Over the past few decades street design has failed to satisfactorily address the needs of pedestrians and cyclists, with street layouts designed for the benefit of cars above all. More recent developments have become more permeable, although they can lack legibility, with the car driver often losing themselves in the layout.

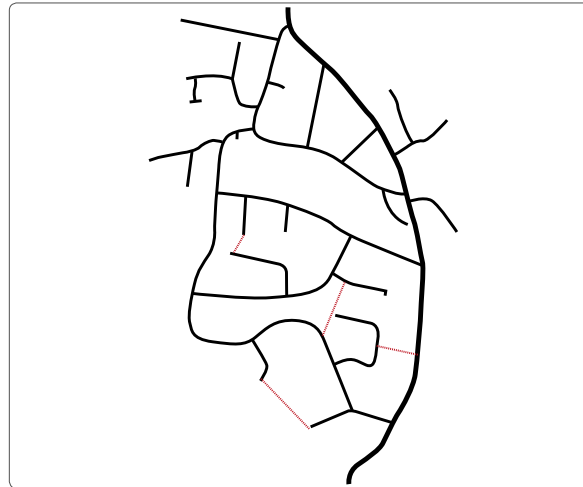

Fig 3.3.10 to 1950s/1960s – combination of linked roads and cul de sacs

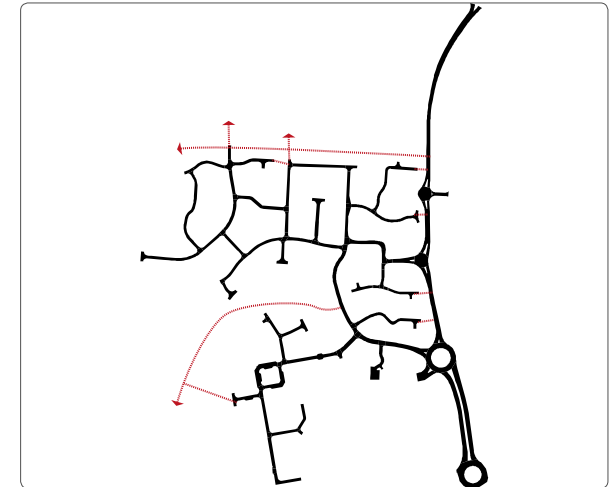

Fig 3.3.12 to 1990s – improved pedestrian routes but still car dominated with overengineered design features



Fig. 3.3.9 to 1900 – very permeable road network

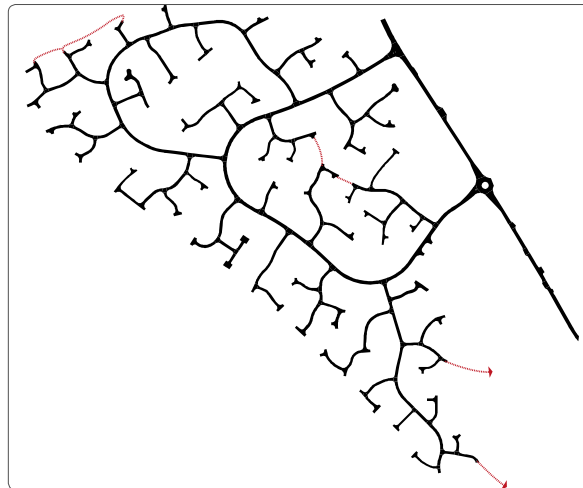

Fig 3.3.11 to 1980s – designed around car use from distributor roads with very poor connectivity



Fig 3.3.13 - Early 2000s – modern infill with good connectivity and linkages to surrounding streets and spaces.



Pedestrians

When designing pedestrian routes the quality of the public realm should be uppermost in the designer's mind.

The use of high quality materials and generous high quality landscaping will encourage walking.

Specifications should not just be 'policy compliant' and meet the minimum acceptable standard. The details and use of materials must be design led.

Designers should be aware of potential desire lines (usually the shortest and most convenient routes between two places) and ensure that direct routes that people may use are designed into any scheme. There are examples where pedestrians choose the most direct route to a place or location, known as 'desire lines', whatever is in the way, and this has not been considered in the development.





Cycling

Huntingdonshire’s relatively flat topography makes it a good area to encourage cycling, and safe and direct routes for cycling within and to larger developments are essential. Key considerations for the creation of cycle routes include:

- Integrating cycle routes on lower speed streets (below 20mph)
- Provide dedicated cycle lanes/routes on streets that have traffic speeds over 30mph
- Provide “continental style” segregated on street cycle routes
- Combine cycle route provision with walking routes integrated within greenways or wider pavements
- Provide well designed secure and covered structures for cycle parking that are either integrated into the public realm or within the private grounds of buildings or gardens, and close to the entrance to public buildings.



For further information use the following weblink:



Sustrans handbook for cycle friendly design

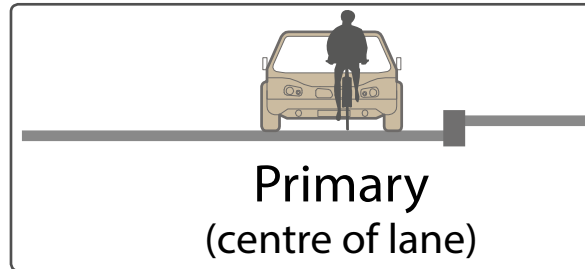

Cyclist primary riding position

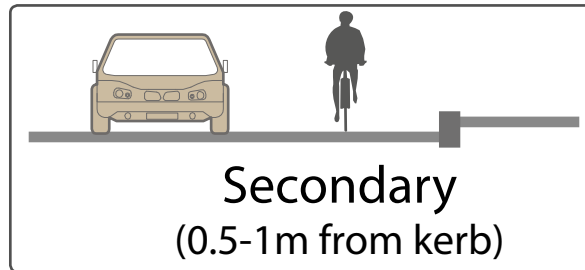

Cyclist secondary riding position



Cycle paths converge - St Neots

Safe and direct routes for cycling within and to larger developments are essential



Assen, Netherlands





Access

The needs of all the users of any development should be taken into account in the design process. This includes children and their carers, elderly people and people with disabilities. Designs should encourage social interaction while facilitating movement.

The aim should be to create as far as possible a barrier free environment.

Gradients, changes in level, openings, boundaries, textures and colours, lighting, shelter, street furniture and parking areas should have regard to the full range of age and abilities at the outset in the design process.



Barrier to movement



Barrier to movement



St Neots, Cambridgeshire





Safety and Crime Prevention

Designing out crime and designing in community safety are essential to the creation of successful safe and attractive developments, which work well, and where people want to live.

Seven key attributes are particularly relevant to crime prevention in new developments. None of these are prescriptive nor are they a set of rules. However they are useful indicators to use when designing and commenting on new developments.

1. Access and movement: places with well-defined routes, spaces and entrances that provide for convenient movement without compromising security
2. Structure: places that are structured so that different uses do not cause conflict
3. Surveillance: places where all publically and semi-publically accessible spaces are overlooked
4. Ownership: places that promote a sense of ownership, respect, territorial responsibility and community
5. Physical protection: places that include necessary, well-designed security features

6. Activity: places where the level of human activity is appropriate to the location and creates a reduced risk of crime and a sense of safety at all times
7. Management and maintenance: places that are designed with management and maintenance in mind, to discourage crime in the present and the future

For further information use the following weblink:

Safer Places – The Planning System and Crime Prevention

SecuredbyDesign.com





Street Types

The following pages describe the various street types that can be found within Huntingdonshire, defining them by their capacity and character.

The types of street to be included in any new development are key to its overall character.

As well as providing access to buildings and the services to them, they are one of our most important public spaces, and it is fundamental to design streets for all uses and users, not just the car.

Each street type has a table with additional information which gives recommended overall dimensions for all new highways.

Early engagement with Cambridgeshire County Council, as highway authority, is encouraged with regards to the design of all street types, highway adoption and parking solutions.





Street Type 1 - Distributor Street

Distributor roads are the widest street types for movement through larger urban areas. This street type should include lanes for buses and cycles where appropriate. Trees located within landscaped verges are an important part of these kinds of streets.



The Boulevard, Alconbury Weald (one half)

Distributor Street	
Corridor width	Up to 41 m
Carriage width	5.5 - 6.5 m
Parallel parking / landscape verge	2.5 - 4 m
Cycle lane	3 m shared with footpath
Footpath / service corridor	2 m minimum unless included with cycle path (3 m)
Building setbacks / privacy strips	Varies
Bus Lane	3.5 m where applicable
Comments	Follow guidance in Manual for Streets
Parking	On-plot parking provision
Cycle	Segregated cycle lanes to be provided
Speed	Max 30 mph

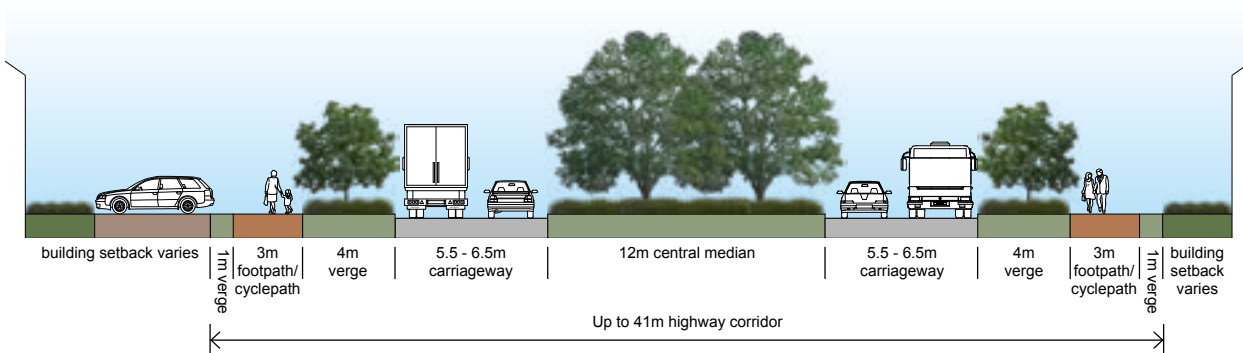



Street Type 2 - Primary Street

Primary streets are main roads through residential and commercial areas. This street type should include lanes for buses and cycles where appropriate. Trees located within landscaped verges are an important part of these kinds of streets.



Stone Hill, Loves Farm St Neots

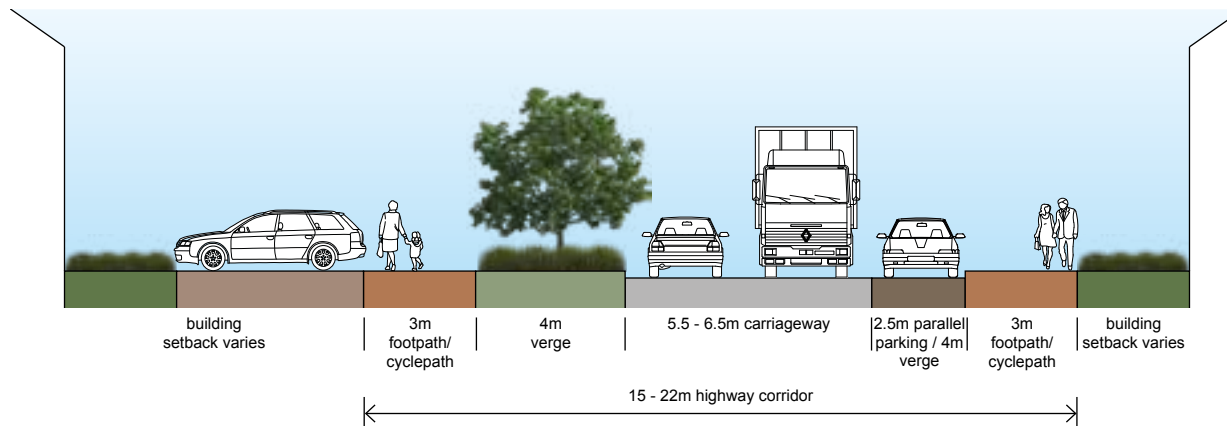

Primary Street	
Corridor width	15 - 22 m
Carriage width	5.5 - 6.5 m
Parallel parking / landscape verge	2.5 - 4 m
Cycle lane	3 m shared with footpaths
Footpath / service corridor	2 m minimum unless included with footpaths
Building setbacks / privacy strips	Varies
Bus Lane	3.5 m where applicable
Comments	Follow guidance in Manual for Streets
Parking	On street parking to be encouraged, but avoid its dominance by attractive landscaping and public realm works
Cycle	Segregated cycle lanes to be provided
Speed	30 mph





Street Type 3 - Secondary Street

Secondary streets are less formal than the Primary Street type, provides access from the Primary Street to residential areas, connecting to internal tertiary streets.



Buttsgrove Way, Huntingdon

Secondary Street	
Corridor width	10.5 - 20 m
Carriage width	5.5 - 6.1 m
Parallel parking / landscape verge	2.5 - 4 m
Cycle lane	3 m shared with footpath
Footpath / service corridor	2 m minimum unless included with cycle path (3m)
Building setbacks / privacy strips	Varies
Bus Lane	None
Comments	Follow guidance in Manual for Streets
Parking	On street car parking in lay-bys and localised road widening and on-plot provision
Cycle	Cycle lanes are part of carriageway width
Speed	Max 20mph where set, otherwise 30 mph

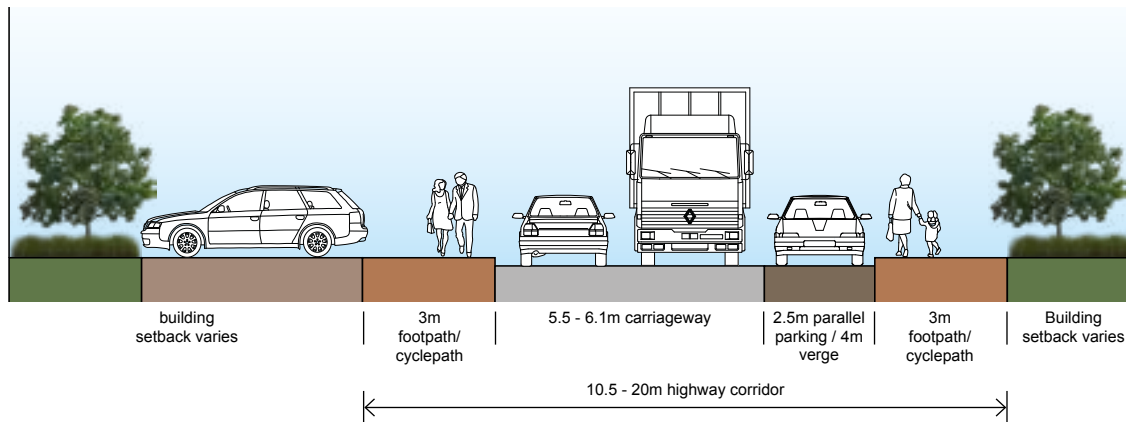



Street Type 4 - Tertiary Street

Tertiary streets are less formal than Secondary Streets (Type 3), provides access to residential areas.



California Road, Huntingdon

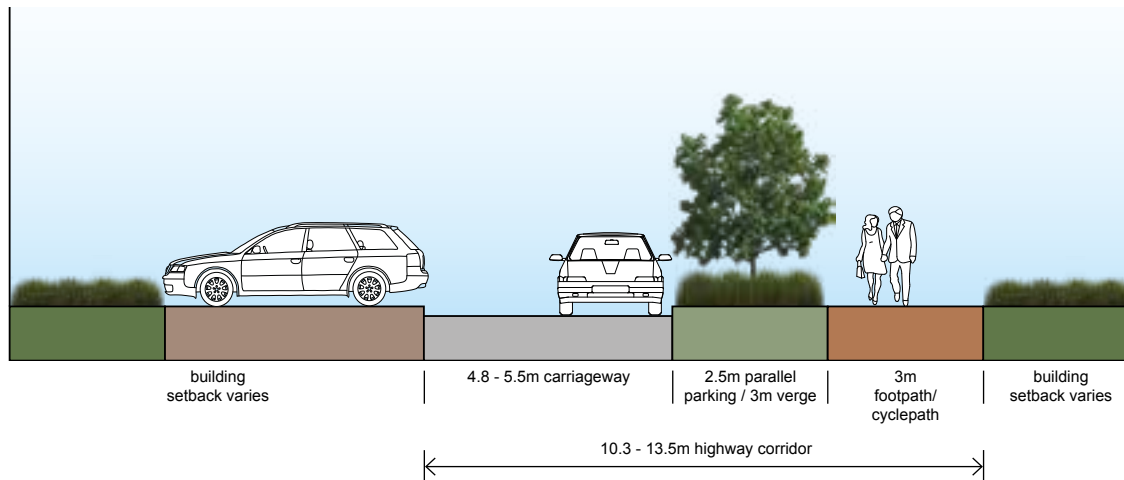

Tertiary Street	
Corridor width	10 - 13.5 m
Carriage width	4.8 - 5.5 m
Parallel parking / landscape verge	2.5 - 3 m
Cycle lane	None
Footpath / service corridor	2 m minimum unless included with cycle path (3m)
Building setbacks / privacy strips	Varies
Bus Lane	None
Comments	Follow guidance in Manual for Streets
Parking	On street car parking in lay-bys and localised road widening and on-plot provision
Cycle	Cycle lanes can be part of carriage width
Speed	Max 20 mph where set, otherwise 30 mph



Street Type 5 - Home Zones and Shared Surfaces

This innovative street type gives priority to pedestrians, cyclists and children’s play. This type of street does not have a clear division between pedestrian and traffic areas and will assist in reducing the speed of vehicles and thereby increase the safety of residents and children. Home zones must be appropriately planted and can accommodate street furniture and play areas to encourage social interaction. On-street parking should always be included in the layout of the home zone. Traffic calming

features such as street narrowing, changes in direction, a curvilinear profile and landscaping may also form an integrated part of the design of the home zone.



Moorhouse Drive, Huntingdon

Home Zones and Shared Surfaces	
Corridor width	Up to 9.5 m
Carriage width	4.8 -5.5 m minimum within a wider shared space with frequent traffic calming measures
Parallel parking / landscape verge	2.5 - 3 m
Cycle lane	None
Footpath / service corridor	None
Building setbacks / privacy strips	Varies
Bus Lane	None
Comments	Follow guidance in Manual for Streets
Parking	On street parking in lay-bys or localised street widening and on-plot provision
Cycle	Cycle lanes are part of carriage width
Speed	Max 5-10 mph

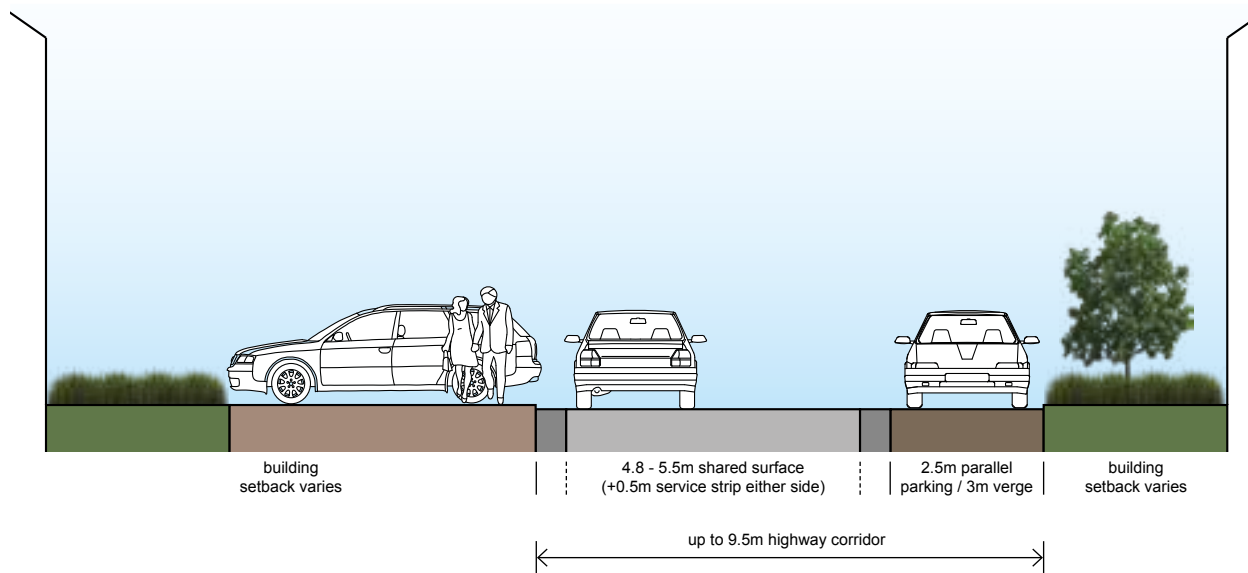



Street Type 6 - Mews

This street type was traditionally a service road provided to the rear of buildings, and which historically provided access to out-buildings. Contemporary approaches to mews streets may apply to a row or group of houses and garages built around a narrow tertiary street. Mews streets are good at providing on street parking. They also provide increased levels of pedestrian safety because vehicle speeds are kept to minimum.



Loves Farm, St Neots

Mews	
Corridor width	Up to 9.5 m
Carriage width	4.8 - 5.5 m minimum with a wider shared space with frequent traffic calming measures
Parallel parking / landscape verge	None
Cycle lane	None
Footpath / service corridor	None
Building setbacks / privacy strips	Varies
Bus Lane	None
Comments	Follow guidance in Manual for Streets
Parking	Informal on street parking or localised street widening and on-plot provision
Cycle	Cycle lanes are part of carriage width
Speed	Max 5 - 10 mph

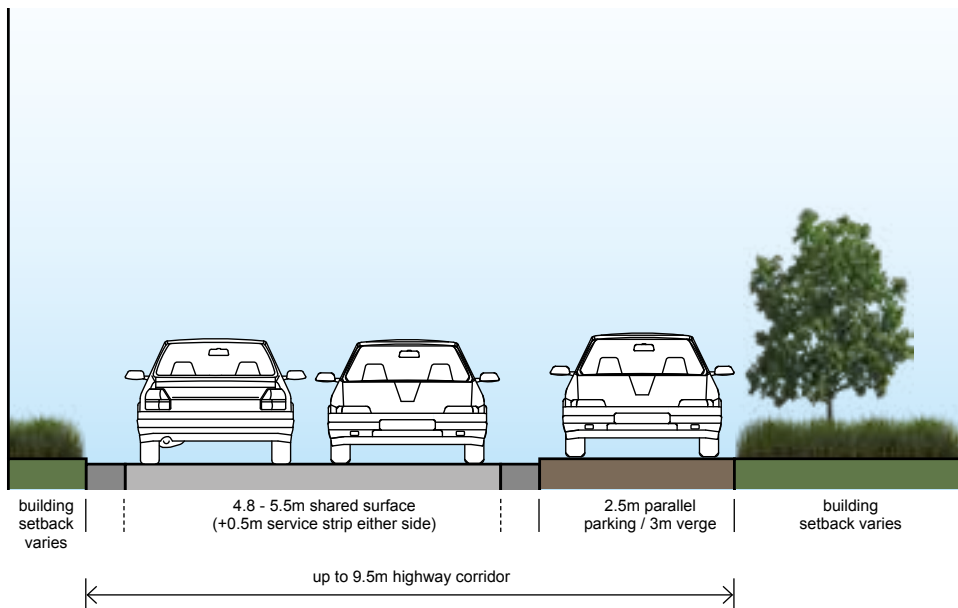

B

H

←

→



Street Type 7 - Business Park or Employment Area

This street type usually has a wider carriageway, designed for a large number of heavy goods vehicles. It is very important that sufficient parking (HGV, car and cycle) within employment areas is designed into the scheme from the outset so that informal on-street parking is avoided.



Wide path with trees

Business Parks or Employment Areas	
Corridor width	18 m minimum
Carriage width	7.3 m
Parallel parking / landscape verge	2.5 - 4 m
Cycle lane	2 m minimum unless included with cycle path (3 m)
Footpath / service corridor	None
Building setbacks / privacy strips	Varies
Bus Lane	None
Comments	Follow guidance in Manual for Streets
Parking	On-plot provision
Cycle	Cycle lanes are part of carriage the width
Speed	Max 20 mph where set, otherwise 30 mph

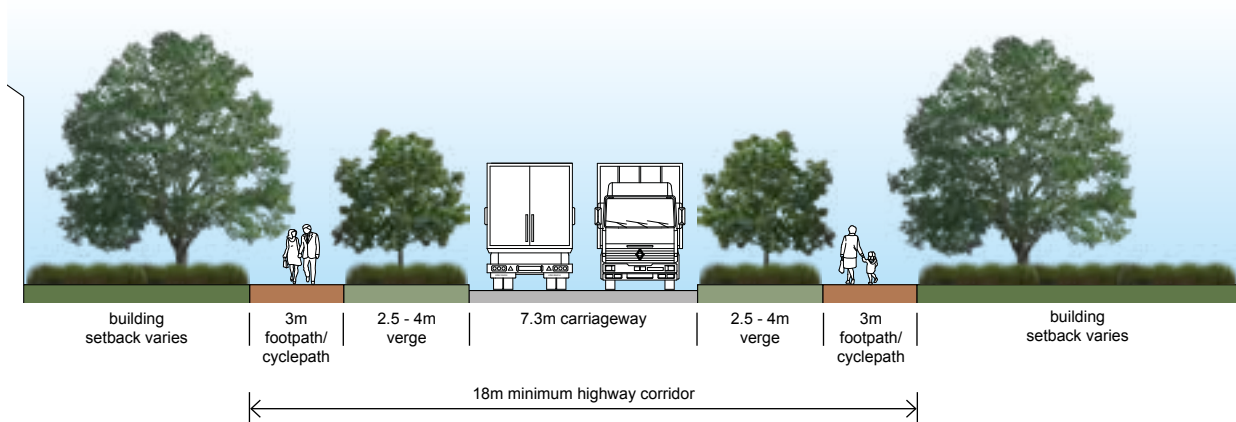



Building setbacks

A setback is the distance between the back of the pavement and the building line. The size of the setback contributes to the overall character and sense of enclosure along a street.

Different land uses require different building setbacks depending on their requirements for privacy and parking, and what adjacent uses and street types there are. In rural and low density areas, setbacks are generally much deeper, and houses usually include relatively deep front gardens.

The street types shown on the previous pages also provide guidance for appropriate building setback distances from the pavement, and these vary relative to those different street types. In more rural areas, a coherent street frontage should be achieved by coordinating the setback between buildings and the street. Large differences in setbacks for adjacent properties should be discouraged.

In business parks or other employment areas, the setback distance from the plot boundary should be relatively shallow, but this setback distance should be well landscaped. This setback area can also be used for a landscaped drop-off point or for parking.

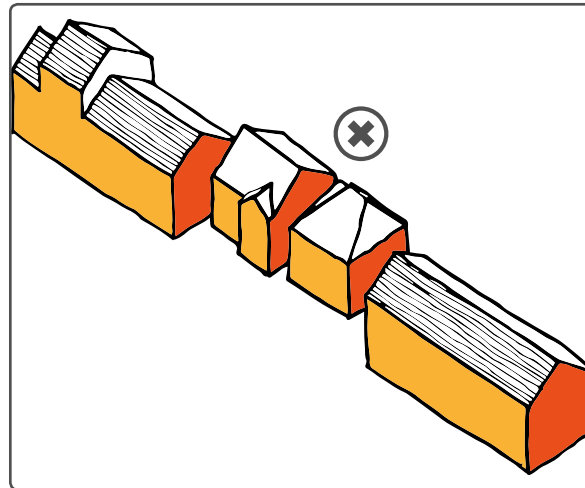

New buildings should respect the established building line



Buildings set back a similar distance - Great Gransden

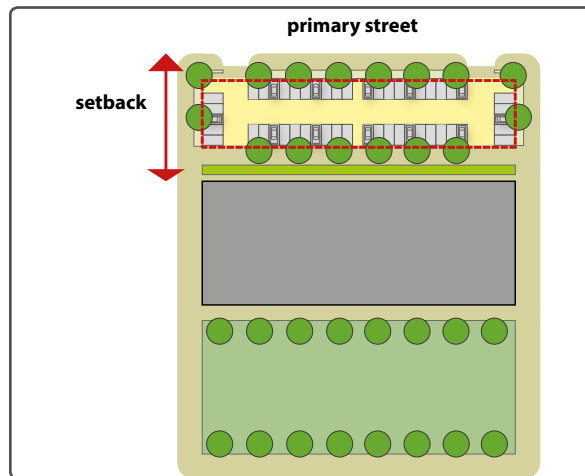

How to set back a large building from the street



Office building set back from the street to allow some car parking to the front

(B)

(H)

(←)

(→)



3.4 Urban Structure and The Development Block

‘Urban structure’ means the pattern or arrangement of development blocks, streets, buildings, open spaces and landscape. It applies equally to the centre and the suburb, everything in between, the town and the village.

How the urban structure is broken up is described as the ‘urban grain’ - the balance of open space to built form, and the nature and extent of subdividing an area into smaller parcels or blocks. For example a ‘fine urban grain’ might constitute a network of small and highly detailed building blocks. It takes into consideration the hierarchy of street types, the physical linkages and movement between locations, and modes of transport.

A key element of urban grain is the development block or perimeter block.

The size and arrangement of any development block will vary depending upon its location and its density. Different block sizes create variety in the urban fabric. Larger blocks provide greater flexibility and adaptability and are best suited to urban areas with opportunities for the centre of the block to accommodate parking, a mix of

uses, shared gardens and pedestrian routes. It is less relevant to lower density areas in rural locations.

A combination of block sizes present opportunities for adaptability over time. Generally speaking a block size of 60-90 metres in length can accommodate a variety of uses, but larger building uses such as industrial areas, supermarkets and warehouses require larger block sizes.

The perimeter block is the classical way of laying out buildings and spaces. It is defined by a perimeter of buildings facing a street or a public space, with a clear distinction between public fronts and private/semi-private backs. Variations of the theme include:

Back-to-back gardens: This type is defined by a series of houses with private back gardens in the centre. Such housing can be terraced, semi-detached or detached, depending upon the context of the site.

Courtyards: Perimeter buildings defining a communal or private courtyard in the centre. This courtyard can be permeable or non-permeable.

The following principles should be considered within a development block:

- Make a clear distinction between public fronts and private backs
- Provide continuous built frontage to create enclosure along key streets and spaces
- Design buildings with suitable size, scale and massing for its context, location, land use and density
- Create a building arrangement that produces an easy to understand structure
- Enable street orientation to optimise natural daylight and the solar potential for buildings by having its longest dimension along east- west axis (or within 30 degrees of south)

In large schemes, blocks can be sub-divided into smaller land parcels to allow development by multiple applicants and allows for a richer mix of building types and a greater number of development uses.

All this is analysed in more detail on the next few pages:-





St Neots town centre is defined by some relatively large development blocks. Some of them are divided by footpaths and have focal buildings to help navigate around.

Loves Farm is defined by many small linked development blocks, with strategic green spaces providing links between. The key focal points of shops, school and rail station are linked by long distance routes.

Key

- Development blocks
- Formal public open space
- Informal public open space
- Focal public space
- Service areas within a block
- * Key building
- ↔ Principle vehicle movements
- - - Cycle and footpath routes
- - - Routes within a development block

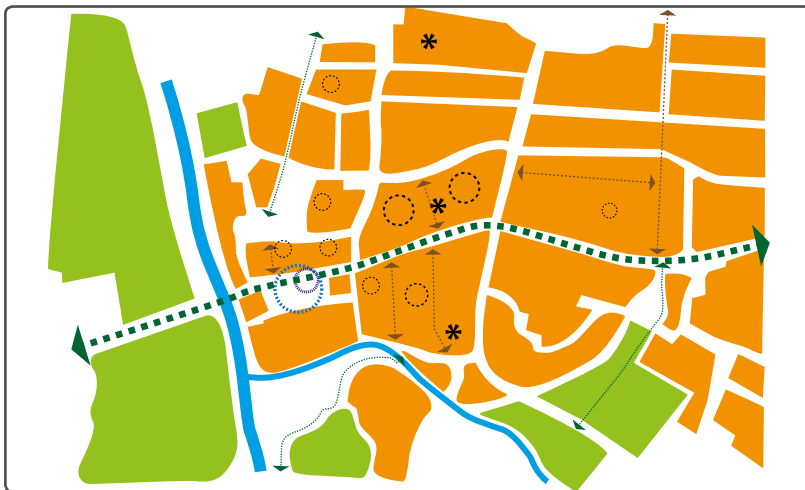

Map 3.4.1 St Neots town centre showing development blocks

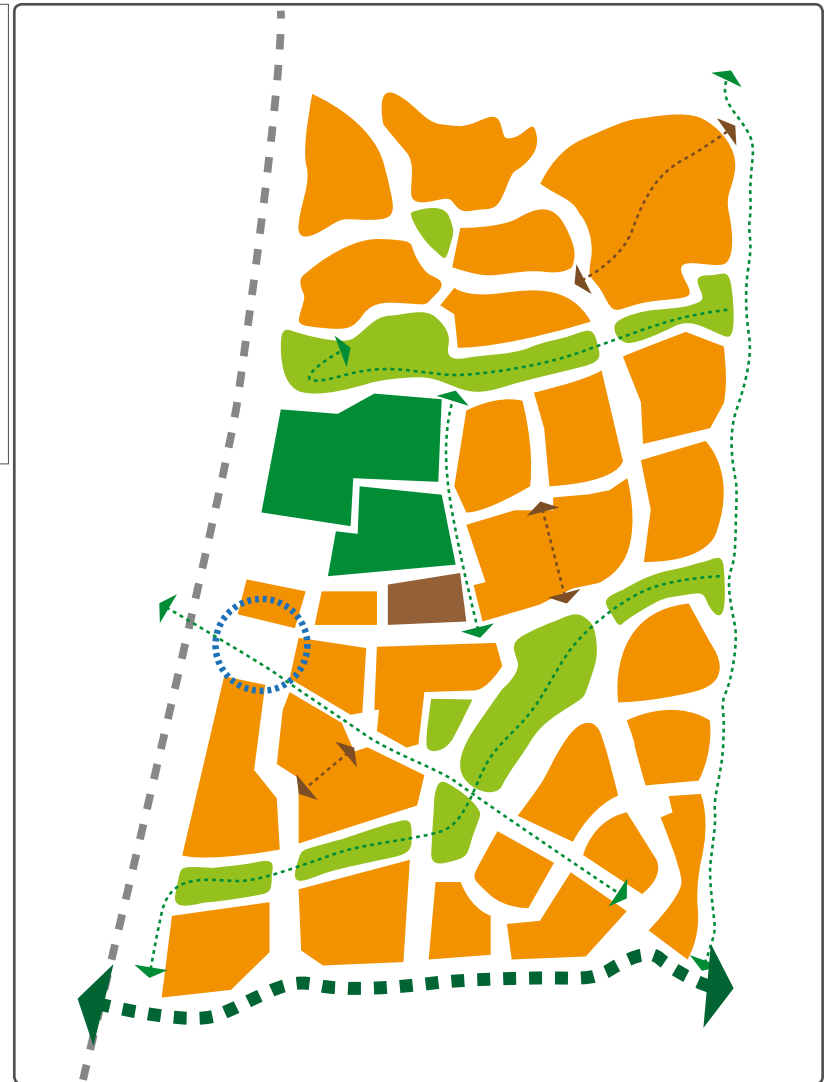

Map 3.4.2 St Neots urban extension - Loves Farm



Front and Backs

It is generally recommended that development blocks are designed with the fronts and backs of buildings being treated differently.

A clear distinction should be made between public fronts and private/semi-private backs. Buildings framing the public realm and the street should align their public frontage and means of access accordingly, while private or semi-private frontage (including service areas and gardens) should be located to the back.

Blocks that contain pedestrian routes through them should ensure that they are overlooked to provide a sense of security.

Blocks should follow the hierarchy of public-private-public and avoid any fronts of blocks facing the backs of adjacent blocks.

Building fronts should face the street to provide activity, and should avoid long blank walls and excessive runs of garage doors.

Ground level residential units that face public fronts should be carefully designed with robust boundary treatments and defensible space.

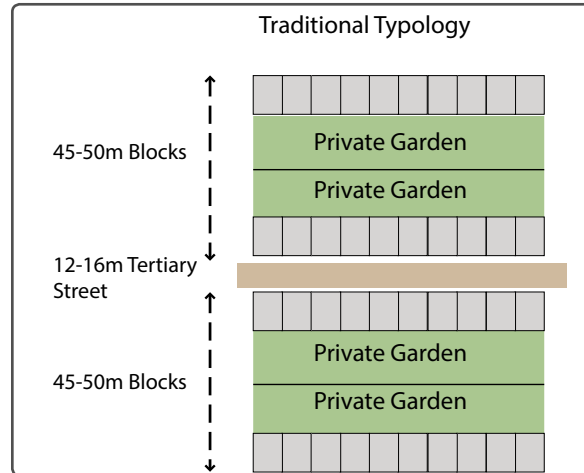

Fig 3.4.1 Fronts and backs



This is a poorly designed car court with ill defined fronts and backs



Attractive relationship between buildings and street.



This is an example of buildings not relating to the the street - Needingworth

B

H

←

→



The uses within the interior of a block are usually defined by that block’s size, scale and land use.

Interior courts should be flexible to enable a variety of treatments depending upon its location and context. This may include car parks, service yards, play space, private gardens, communal areas, mews streets etc.

Courtyard blocks should have appropriate scale and size of courts or communal areas. Building height to courtyard width ratio of 1:2 is an ideal rule-of-thumb in urban areas.

Block interiors should retain a clear privacy distance between properties and appropriate boundary or screening treatments.

For residential uses, a 25m distance across the courtyard between properties ensures privacy and sufficient daylight.

If communal gardens or courts are proposed within blocks these should be robustly landscaped.

- B**
- H**
- ←**

All the environmental and servicing requirements for residential units should be considered within the block configuration, including the provision of private green space, car parking, bin storage and other utilities.



Attractive courtyard space



Well landscaped courtyard space





Enclosure

Buildings need to define and enclose the spaces that lie between them in order to achieve a cohesive and satisfactory urban form, and to help create 'serial vision'. It is the sense of enclosure of these spaces that generally creates an attractive environment.

Enclosure works when urban blocks are built in proportion, and when they provide continuous walls that clearly define spaces at the back of the pavement. For instance, buildings should be at least as high as the street is wide and in high density areas blocks should be made of buildings that join together at the back of the pavement.

The number and size of the gaps in the street frontage has a significant impact upon the degree of enclosure. Traditional urban areas built at relatively high densities tend to feature continuous building frontages punctuated by occasional streets, lanes and archways. By

contrast many suburban housing schemes are dominated by detached and semi detached houses separated by modest gaps and garages. This gives little sense of enclosure, hinders energy efficiency and makes poor use of land.

Successful streets and spaces are usually framed by buildings that demonstrate a continuity of frontage and an appropriate sense of enclosure.



Map 3.4.3 This map of Victoria Square in Huntingdon shows the amount of building enclosure. It is this detail that contributes more than anything else to the success of this as a place

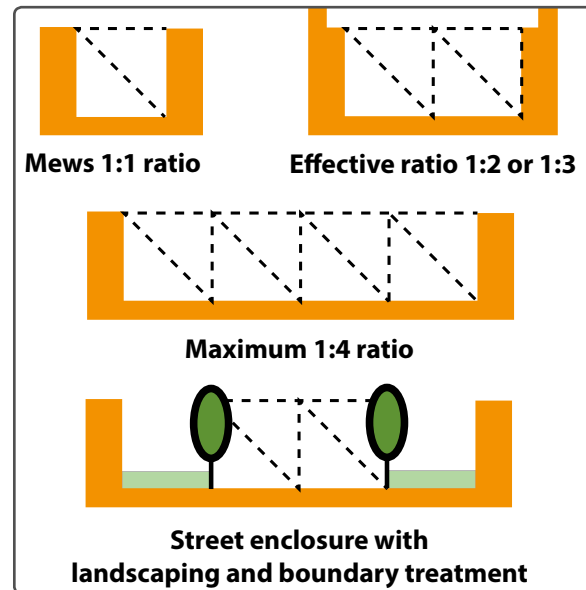

Fig 3.4.2 Street enclosure





These maps showing two of the most attractive spaces within our towns and villages, Broadway in St Ives and Kimbolton High Street.

The quality of these spaces is entirely created by the sense of enclosure and the views out.

These are both very successful townscapes.



St Ives Broadway



Map 3.4.4 St Ives Broadway



Each building is of a different height to its neighbour - Kimbolton



Map 3.4.5 Kimbolton High Street

B

H

←

→



To create a satisfactory sense of enclosure the following general principles should be employed:

- Dwellings should be properly linked or properly detached, and narrow gaps between houses should be avoided.
- Building lines should generally run parallel to the back of the pavement.
- The set back of building frontages should ensure an appropriate ratio between street width and building height is achieved
- Suitably proportioned archways or other openings to provide access to the rear of the building can be used to maintain the building line, rather than leaving gaps in the street frontage.
- Buildings should be designed to turn corners and to terminate views.
- By the careful arrangement of buildings to create better street enclosure, and the use of a greater variety of street types, then as well as creating more interesting developments, such design interventions will provide natural traffic calming, and will be safer for pedestrians and cyclists.



Successful building frontage - Little Paxton



Leading the eye in a pleasing way - Kimbolton

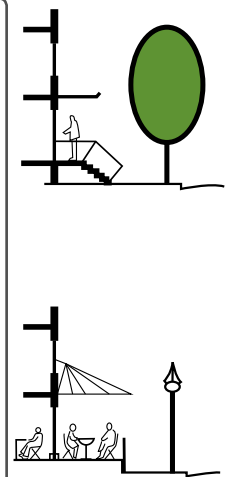

Figure 3.4.3 Building frontage creating variety as well as cohesiveness



Traditional terraces demonstrate that this form of building can make attractive townscales and streetscapes. It is important to create variety in scale and proportion, and the challenge is to develop a family of terrace building types with related characteristics, but which offer different combinations of accommodation, have different plot widths and frontage depths and the ability to achieve subtle changes of direction, leading the eye along a street.

The corners of development blocks should be highlighted by a change in scale or design, ensuring that the gable is enlivened by windows and if the principle elevation, by doors. There are plenty of good examples that demonstrate this approach.



Buildings following the street - St Neots



Corner of development block with changes in scale and design - Little Paxton



Subtle changes at the end of the terrace - St Ives



Tracking

Tracking, or swept path analysis, is used to determine the space required for various vehicles and is a key tool for designing carriageways for vehicular movement within the overall layout of the street.

The potential layout of buildings and spaces do not have to be dictated by the carriageway alignment.

The layout of buildings and spaces should be designed first, with the carriageway designed to fit within the remaining space. This will help to prevent a 'scalectrix' type street design (see Figure 3.27).

The Department for Transport's document 'Manual for Streets' has laid out the principles for assigning a higher priority for pedestrians and cyclists 'by setting out an approach to residential streets that recognises their role in creating places that work for all members of the community.' This document can be found using the weblink below:-

Manual for Streets

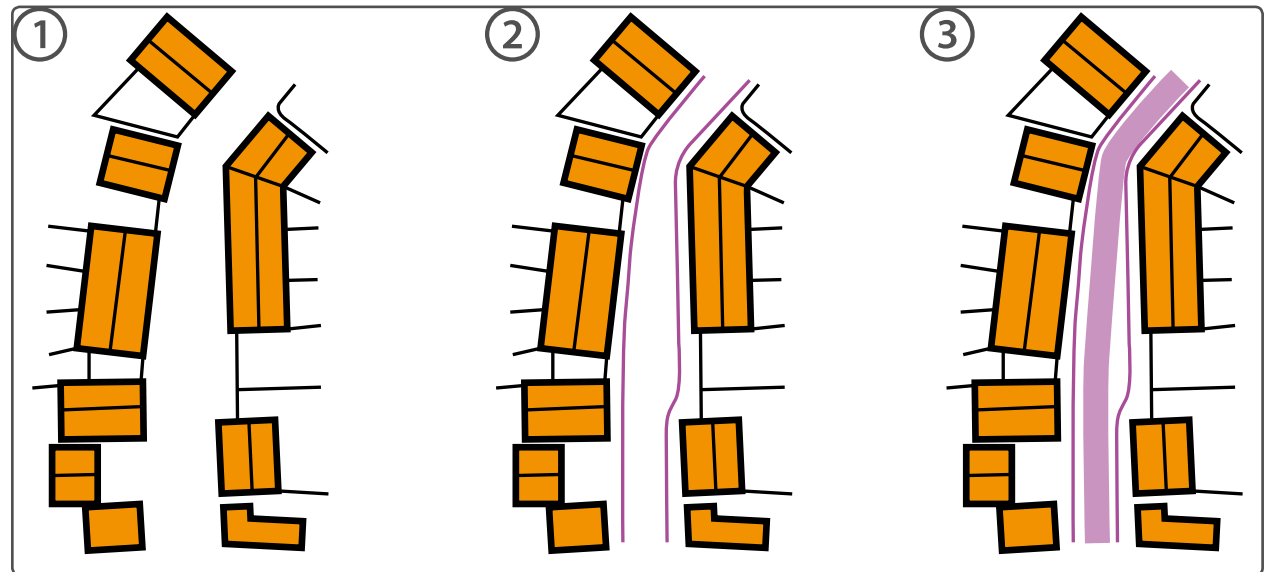

Figure 3.3.4 how to determine the space required for vehicles





Activity and Frontage

Successful streets and spaces usually create activity in and around the buildings.

Successful streets and spaces are created where activity occurs. Activity is generally created through a mix of uses within a location and good building design. The form of a building with doors and windows fronting out onto streets and spaces helps to stimulate activity and interaction.

Where this occurs in building succession, activity can be generated. Activity is also created through the use of outside spaces, eg the use of tables and chairs allowing people to sit and relax, or through the holding of events such as markets or fairs.



Activity created by a new cafe opened in a refurbished old building in St Ives



Active frontages - St Ives town centre





'Big Box' Frontage

'Big box' uses (office, industrial, retail, warehouse or cinema multiplexes) in urban areas should provide for active frontages overlooking public spaces and routes. They should be screened by smaller buildings that wrap around the building, or by the use of substantial landscaping, areas of public realm and interesting materials such as green walls and decorative architectural detailing.

Activity-generating functions within a building, such as entrances, reception areas, cafeterias and offices, should be located so that they can enliven the principal elevation, overlooking the street and the approach to the building.

This can provide windows and natural surveillance to the street and communal areas of a development, and bring interest and variety to the building frontage. If possible cafeterias/ restaurants/ cafes should spill out onto the frontage providing interaction and vibrancy to the street.

In other non urban areas, it is still important to ensure that active frontages are provided overlooking public spaces and routes, but a variety of approaches to dealing with this design issue can be used, depending upon the site's sensitivity. For more details see the following page.



Screening a large food store behind some smaller shops

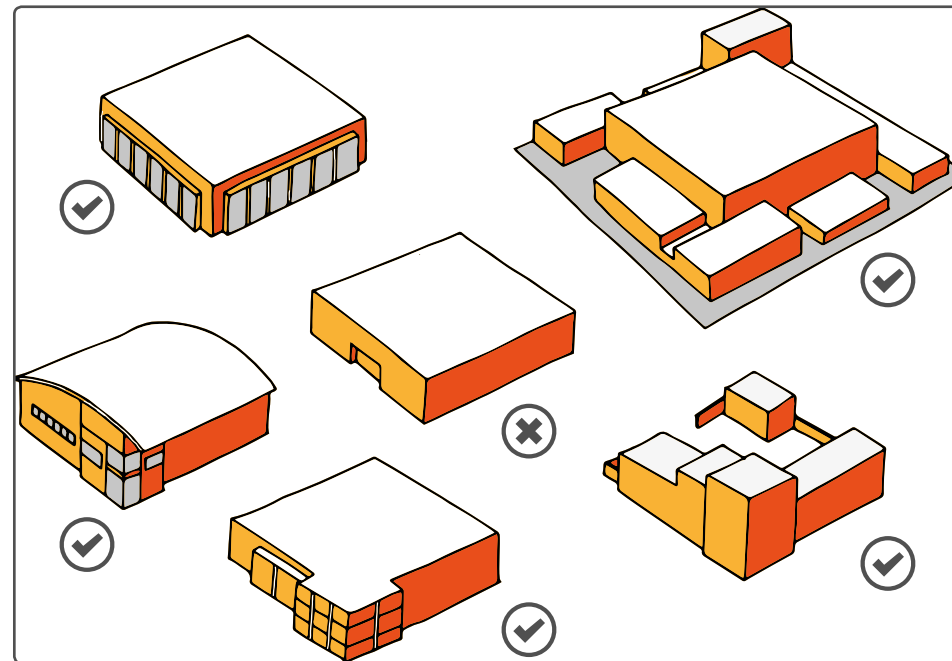

Figure 3.3.5 Various options showing how to break up the massing of 'big box' buildings



Siting of Industrial and ‘Big Box’ Type Uses

The siting of large buildings and industrial units should reflect the context and topography of the surroundings. It may be appropriate to produce scale models or axonometric sketches of any development proposals to demonstrate the impact of any buildings in the landscape and townscape taking account of any constraints e.g. flood risk.

New industrial warehouse and retail buildings are often large structures with limited active frontages. Integrating landscape screening along with setting back any building to improve its relationship with the street should be considered.

The following elements should be thought about within any new design:

- To ensure that the appearance and potential impact of new buildings from various viewpoints is mitigated, avoid the siting of ‘big box’ buildings on the top of

hills or within sensitive view corridors.

- Take advantage of existing topography to be less visually intrusive (for example placing the building on lower slopes relative to where it will be mainly viewed from).
- Think about the use of windows to both add interest to the elevation but also add natural light to the inside of the building.
- Think carefully about the materials that will be used for the walls and roofs, and potentially use innovative approaches such as the use of green roofs and digging the building more into the land.
- Parking and servicing should not dominate the primary frontage of the plot. Parking and servicing should be accommodated at the rear or along the side of the building, and these areas should be landscaped.
- Canteens, offices, entrances, foyers, glass façades and advertising features should be located along the street to create active frontages.
- Siting smaller units in front of larger ones will reduce the impact of any larger building.



Supermarket with entrance and active frontage to the street



Entrance adds interest to street frontage and provides natural light





Figure 3.3.6 - Infill of 'big box'/industrial units

Different scenarios for siting 'big box'/industrial type buildings adjacent to a primary street:

- **Scenario 1:** Building set back with parking and servicing along the main frontage. This breaks the continuity of the street frontage
- **Scenario 2:** Building facing onto the street. Problems with locating main entrance and active frontages on the street if the parking and entrance is from the rear
- **Scenario 3:** Ideal setting with entrance and active frontage along the street, with easy access for parking and servicing

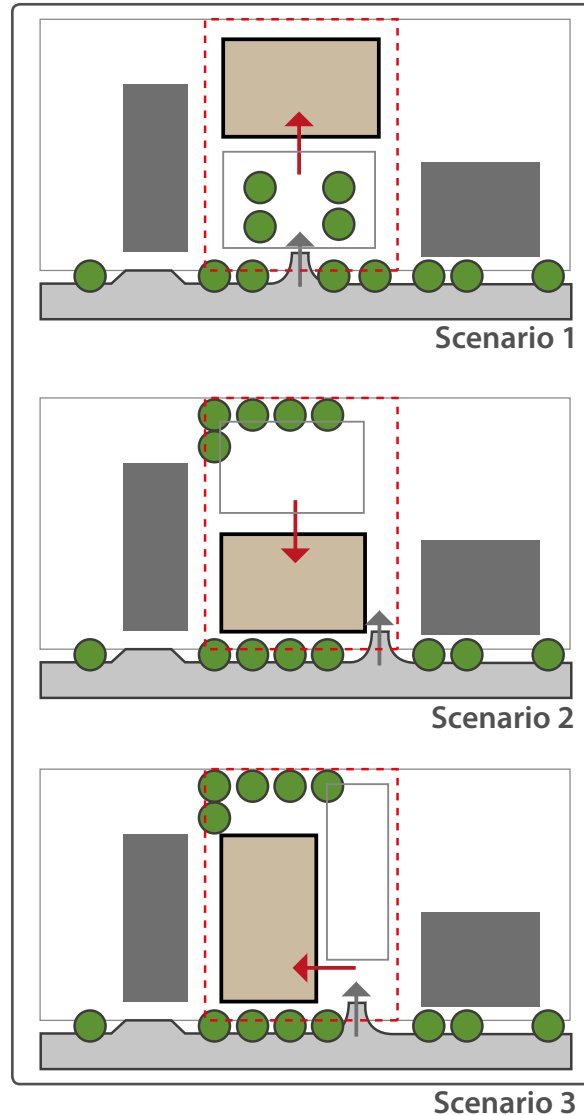

Figure 3.3.6 - Infill of 'big box'/industrial units

Figure 3.3.7 - Siting of 'big box'/industrial units

Different scenarios for siting 'big box'/industrial type buildings on topography:

- **Scenario 1:** Dominant building sited on top of hill, likely to be unacceptable due to its visual impact
- **Scenario 2:** Building sited flat on the slope
- **Scenario 3:** Building sited partially within the slope to reduce its visual impact
- **Scenario 4:** Ideal setting with building integrated into the slope

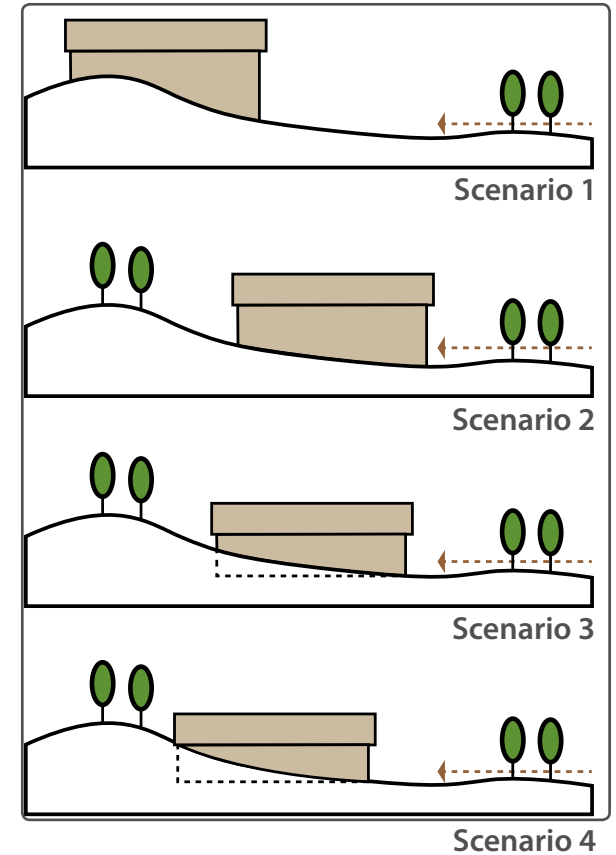

Figure 3.3.7 - Siting of 'big box'/industrial units

(B)

(H)

(←)

(→)



Different examples of development types within a block

Block Type: Back to back garden development

This is the normal default position of most residential development, with back gardens backing onto back gardens, providing secure rear garden spaces.



Back to back gardens



Terraced development fronting the street - Temple Place, Huntingdon



Attractive example of how buildings can relate to the street - St Ives

Back-to-Back Gardens	
Location	Everywhere
Layout	Houses along streets with private back gardens
Land use	Residential / mixed use
Massing	1.2 - 5 storey high
Frontage	Public street frontage
Pedestrian access	Entrance along street frontage
Vehicular access	-
Parking	On street, driveway, in structure (garage or integral)
Ground floor treatment	Active frontage with defensible space
Privacy	Boundary treatment, setback required, avoid overlooking
Servicing	Side access and / or ginnel
Key dimensions	Back to back dimension between buildings - minimum - 21m





Block Type: Courtyards

Courtyard developments offer an interesting arrangement of dwellings often grouped around a shared area of landscaped open space or heavily landscaped parking area or combination of both. Active frontages are onto the main street and within the courtyard centre. A mix of parking solutions are available including integral or undercroft or within the courtyard itself. Services are often integral within the building or designed within the courtyard.



The courtyard garden



Shared gardens



Active and supervised courtyard

Courtyard within the Perimeter Block

Location	Urban, suburban and rural
Layout	Buildings arranged along the perimeter with a central space
Land use	Mixed use, residential, commercial
Massing	Courtyard proportion should have minimum height to width ratio of 1:2 minimum, higher corner buildings
Frontage	Active frontage to the street and communal courtyard, strong built frontage
Pedestrian access	Entrances from the street and within the courtyard
Vehicular access	Access from the street
Parking	In structure (integral or undercroft), or in a separate location, basement or surface within the courtyard with landscaping
Ground floor treatment	Active frontage to the street and courtyard including mixed use
Privacy	Residential use fronting the street and courtyard with defensible space required
Servicing	Within the building or screened within the courtyard





Block Type: The urban square

This example is where a pedestrianised landscaped area provides the active open space focus for the area, with both cars and pedestrians sharing this active space. Car parking is usually addressed through a combination of on street and driveway approaches, with small courtyards where appropriate.



Urban square



Successful place making

The active courtyard	
Location	Urban - suburban
Layout	Permeable perimeter block
Land use	Residential and mixed use
Massing	Generally medium rise buildings, with focal buildings on corners and along vistas
Frontage	Continuous frontage with occasional breaks
Pedestrian access	Entrances along frontage and from within the court
Vehicular access	Access from street
Parking	On street or driveway, with small courtyards where appropriate
Ground floor treatment	Mixed use should have active frontages
Privacy	Residential use facing the courtyard and street with defensible space
Servicing	Service yards should be screened
Key dimensions	Maximum 4 storey building



Block Type: Infill inside the block

These generally higher density developments take place within existing block structures, and are often designed around what can often be substantial constraints, such as trees and existing buildings. The results often demonstrate ingenuity in the design.



Infill development - St Ives (photo shown below)



High density infill relationship with trees



Contemporary Infill development - St Ives

Infill Block	
Location	Urban
Layout	Buildings designed within existing blocks as infill with limited frontages
Land use	Residential, mixed use, commercial
Massing	Appropriate massing in context with existing buildings
Frontage	Usually continuous built form as high density development
Pedestrian access	Access from existing streets
Vehicular access	Access from existing streets if possible
Parking	In structure (garages or integral), on-plot or on shared surface street
Ground floor treatment	Active frontage
Privacy	Residential defensible space
Servicing	Servicing should be well screened
Key dimensions	Dependent upon constraints



3.5 Parking and Servicing

Car Parking

Research regularly shows that car parking is the aspect of development that provokes most comment from residents and other users.

Where cars are parked is also the key to whether a development has active streets, crucial to making a place feel alive and safe for those living and working there.

Accommodating enough cars to meet reasonable expectations from the owner/user of the development proposed, is an important objective, but the parking debate cannot be exclusively about how much. Whatever the level of car parking, the focus has to be on providing it in convenient locations and making it safe and attractive. This is important for successful place making.

There is a conflict between an individual's desire to own and park a car and the collective desire to enjoy a safe and an attractive street. Parking provision has both positive and negative impacts on the way places look and work.

B

H

←

In providing car parking, consideration must be given to the amount required and importantly how and where it is accommodated in relation to the home and the street. The use of soft landscaping and tree planning should be developed in parallel with the underground service strategy for the site to avoid any future conflicts.

Good parking is inseparable from good urban design practice. It is only through combining good external public environments with good private home environments that successful and sustainable development can be achieved.

These are the 'golden rules' for all locations:

1. Go for the quality of the street above all else. So where you put the parking is more significant than how much.
2. There isn't a single best solution. A combination of on plot, off plot, and on street is the solution, according to location, topography and the market.
3. Rediscover the street as a beautiful car park - people understand how it works, it's efficient and it increases the activity and safety of the street.
4. Maximise the activity between the street

and the house for safer, friendlier streets. New residential areas usually have too few people moving around.

5. Do not park in the back of the development block until on street and frontage parking permutations have been exhausted. Use of the mews or rear court should support on street provision, not replace it.
6. Avoid allocating more than half of parking spaces. Research by Noble and Jencks shows that the more spaces you allocate, the more you have to provide.
7. There are now three types of on street parking: uncontrolled; controlled parking zones (CPZ) where spaces can be defined by user and/or by times; and restricted parking zones (RPZ) where positive parking control does not rely on yellow lines.
8. Provide cycle parking to all parking solutions that is safe and secure.
9. Don't forget Secured by Design principles.

Further reading:

Car Parking: What Works Where (2006)

Design principles for various types of parking are shown in more detail on the following pages.

→

On-street Parking

People like to park their car where they can see it, and this is often on the street in front of their house.

On street car parking that is well integrated with a high quality public realm is the default position for good on street car parking design.

However, the streetscape should not to be dominated by continuous on-street parking spaces. Where possible, tree planting and other gaps between parking bays should be incorporated after every 5 continuous bays of parallel parking. Where there is sufficient space, echelon or angled car parking bays may be used, these have the potential to create more car parking capacity. This should also be broken up after every 5 continuous spaces.

Parking bays should be designed with high quality paving and landscaping elements, and parking areas where soil conditions allow should be designed with permeable paving materials.

Negative aspects of on street car parking involve parking half on the footpath or sometimes completely on the path. This is an unsatisfactory arrangement and often blocks the footpath for legitimate users. To prevent this occurring, ways

of encouraging on street car parking through the improved design of the street should be an important part of any design process. This could involve the subtle widening of the carriageway which should indicate to car drivers where it would be appropriate to park your car.

For further reading use the following weblink:

Manual for Streets page 105

This page shows poor examples, and the following page shows some good examples of on street car parking.



Parking on the grass verge will soon lead to the grass dying



The ways these cars have parked have made it impossible to use the footpath



How can you ensure that inconsiderate car drivers cannot park on the footpath?

- (B)
- (H)
- (←)





This informal car parking is made possible by widening the street and using trees - St Neots



This is a good example in Wansford of how to park cars perpendicular to the street



The use of street trees helps to define car parking spaces - Cambourne



Loves Farm, St Neots



Wansford



Cambourne

Home Zone and Mews Parking

Parking is often a key concern where Home Zones are formed from existing streets, as the scheme is likely to affect the layout (and possibly the number) of on-street spaces. This issue can dominate discussions with residents, particularly in areas where there is little off-street parking. Parking issues will need to be dealt with sensitively and thoroughly by any design team.

Parking capacity problems can be addressed through the design, as Home Zones tend to increase the efficiency of on-street parking. Parking spaces can be arranged in blocks, in echelon or perpendicular to buildings; and the whole width of the street, including the former footways, can be brought into use. On-street car parking should be arranged and clearly identified to avoid unmanaged on-street parking, and so that it does not dominate views of the street or impinge upon the other activities that will take place in a Home Zone and Mews.

Mews parking can incorporate a number of parking solutions including FOGs (Flats over Garages), SOGs (Studios over Garages) and under croft/integral parking so that parking

does not dominate. Home Zones and Mews should contain subtle pockets of landscaping and tree planning to break up areas of parking

For further reading use the following weblink:

Home Zone Design Guidelines (2002)



Parking bays are identified by a change in materials



Successful mews parking, Accordia, Cambridge



In this high density area car parking spaces are identified by the use of different materials

B

H

←

→

On Plot Parking

On plot parking can be either on the driveway, in open fronted carports or in garages. Garages can be designed as free standing structures or carefully integrated as part of a building without compromising architectural character, especially if it is a traditional building type. Garages should be set behind or level with the building line.

Where parking is provided to the front of the plot, the careful design of boundary treatment and material at the transition between public and private areas will be required. Often, too much on-plot car parking too close to the front of houses overwhelms the design of a scheme. Boundary treatments and areas of soft landscape will help to mitigate on-plot car parking. This may include landscape hedges with trees, low walls and hedging with a continuity of high quality surface material between the private and public realms. On plot parking to the front of the house is best provided between the footpath and the street, to ensure that the defensible space between the house and the path is not made up by car parking and that there is no perception of parking 'over the front garden'.

Where on-plot parking is provided, including the use of tandem parking bays, layouts must be designed to ensure that there is sufficient space to provide access to rear gardens, to consider refuse collection requirements and comfortably open car doors on both sides in garages and driveways.



On plot car parking can work well when accompanied with robust and well designed soft landscaping - Cambridge



This is a poor example of where a poorly proportioned car port structure detracts from the wider street scene



Newhall, Harlow

Undercroft, Semi-basement and Basement Parking

This type of parking may be used within urban areas often as part of mixed-use or higher density residential or office blocks. Access points should be discrete and not disrupt the continuity of the street frontage subject to flood risk constraints.

The use of raised courtyards and gardens above the parking deck may be appropriate and could also make efficient use of land.

Access ramps should be carefully located away from junctions so to not obstruct any street movements and care should be taken in areas prone to flooding.

The interface between the undercroft and semi basement car parking and the street should be designed as an integral part of the building composition. Parking elements which face onto the street frontage should be either screened or have enhanced architectural or landscaping design to ensure that the ground floor provides interest.

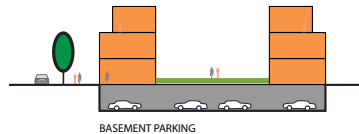
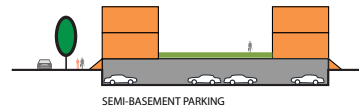
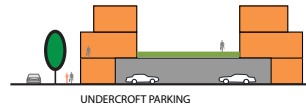

This building uses semi basement parking behind gabions that are designed to let natural light in



This office building has undercroft parking that is well lit by natural light



This building successfully provides car parking underneath



Parking Courts

Communal parking areas may be appropriate for houses, apartments, offices, and other mixed use blocks where there are multiple users at different times of the day. Where possible parking courts should be located at the front of the development to benefit from natural surveillance and ensure that parking is convenient for users and occupants. Experience has found that the use of rear parking courts do not always provide a satisfactory parking solution for development.

High quality and subtle use of materials, integrated landscaping and trees will assist in softening the visual impact and must be incorporated into any design.

Communal parking areas must be overlooked by neighbouring properties. In higher density areas, access to smaller parking courts should be through archways to ensure the continuity of the street frontage.

When using larger parking courts, usually when it is for over eight car parking spaces, they

should be designed as spaces with buildings within them, with the buildings overlooking and supervising these courts as attractive active spaces.

Tandem parking spaces should be discouraged in parking courts, their provision reduces the uptake of spaces, and are often instead used for bin storage. In such situation they are likely to encourage on-street parking.

The use of high quality public realm materials with substantial areas of integrated landscaping will be necessary so that car courts become attractive spaces that will also work as informal play and general amenity when cars are not there.



This recent development has provided for generous planting areas between parking bays



Substantial landscaping within the car parking area



An example of a well landscaped and overlooked parking court, - St Neots

B

H

←

→



Car parking court well overlooked by properties and including lots of soft landscaping



This development in Brampton uses a discreet archway to access some car court parking to the rear, retaining the continuous arrangement of the building form



This same development in Brampton uses a car port structure that is well proportioned and uses high quality materials. It is also used as a cycle and bin store.



This car court is broken up with some attractive areas of landscaping and delineation of parking bays



This archway provides access to a rear car court while preserving the continuous building line



How not to design a car parking area - a harsh place, with no breathing space for any landscaping

B

H

←

✘

→

Employment and Commercial Car Parks

In commercial developments, the best way to alleviate the effect of large parking areas is to ensure that they are designed as an integral part of the landscape. Parking layouts should be obvious and logical and avoid the creation of leftover space. Individual parking bays are recommended to be a minimum of 2.5m x 5m.

Within employment and commercial areas, communal campus style parking is encouraged as this offers a flexible parking solution to meet demand from users of the various buildings. The layout of the car park should be designed with

pedestrians in mind, creating direct, legible and safe routes to building entrances that separate pedestrians from traffic. It is important that external lighting is provided within car parks ([see p120](#)).

Generous areas of soft landscaping and tree planting both within the car park and around its external edge will help to enhance the appearance of the car park. The use of subtle delineation measures to mark out the parking bays will help to create an attractive space.



The consequences of not providing enough car parking



This large commercial car park is broken up by landscaping



This office car park is well defined by a line of mature trees

Large car parking areas should generally be located away from the street. The impact of large areas of car parking can also be mitigated by lowering the finished floor level relative to the road. This is a tried and tested method and works well.



SURFACE PARKING

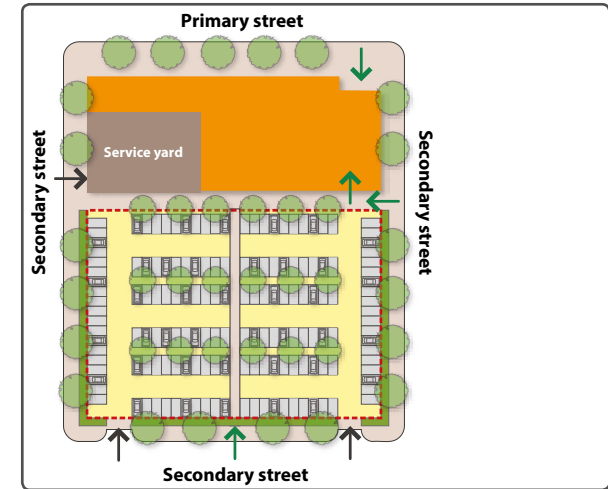

Figure 3.5.4 Car parking and shops



Town centre car parking within a haven of planting

Multi-Storey Car parking

Multi-storey car parking (MSCPs) may help to maximise the potential of a site and reduce the dominance of car parking within the public realm. Proposals for multi-storey car parking should be limited to town centres or other high-density locations.

MSCP's can be large structures and should form part of an urban block. Consideration should be given to wrapping the structure with other buildings to provide an outward aspect and to create active frontages. Green walls and screening façades may also be used as a solution to mitigate the visual impact of such structures.

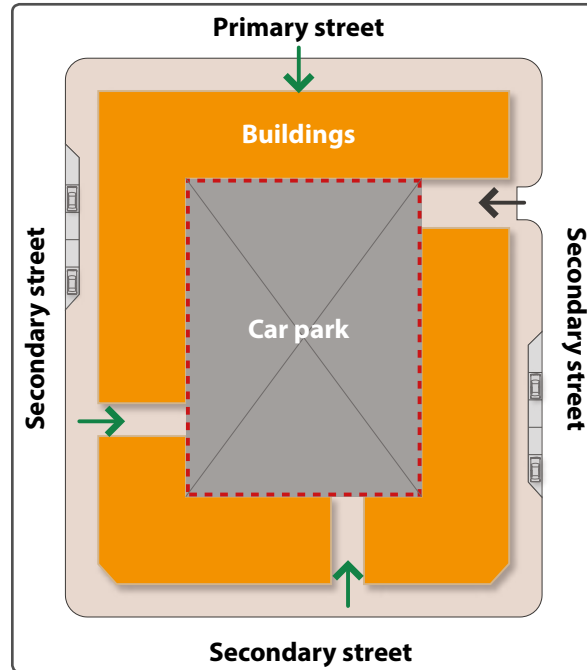

Figure 3.5.5 Multi storey car parking



Huntingdon, Cambridgeshire

Garage Design

Garages are often best designed as free-standing structures, or carefully designed additive forms, as integral garages can dominate and detract from the appearance of a house, as well as reduce the amount of active frontage to the street. Integral garages should not be encouraged unless they are part of a wide fronted house design influenced by distinctive 'outbuilding' house types.

Where garages/integral garages are used as allocated parking spaces, perforate garage doors should be used to discourage the garage being used for storage and to keep the parking space available at all times. Separate personnel doors allow access into and out of the building and improve access where cycles are stored within the garage.

Garages can often be employed to link elements within the street scene (in conjunction with walls or hedges), or to help enclose properties and create privacy between gardens. Garages are ancillary to the house and should not become prominent features. Single garages, each serving a number of properties, should often be combined into one well designed structure to maximise the opportunity

for creating attractive and usable external spaces, as well as enabling more attractive building compositions, often in a mews type environment.

Garages also need to be large enough to be used to park a car comfortably. Key principles to be considered in the design of garages include:

1. Garages to be aligned with, or set back from the building frontage.
2. Single garages must have a minimum of 3m clear internal dimension to allow the door of a parked car to be opened once inside the garage.
3. Garages with a pitched roof should reflect the roof pitch of the existing building and should not result in unresolved and unbalanced building elevations.
4. Garages should complement the architectural style of the existing dwelling or streetscape and be built of similar materials to the existing property or use materials that reflect its use as an 'outbuilding' or subservient building.
5. Houses with integral garages should seek to use design techniques to minimise the impact of the garage on the street frontage.

6. Tandem garages will not count as providing space for 2 cars, as it is very unlikely that 2 cars will be parked in many of this type of garage.

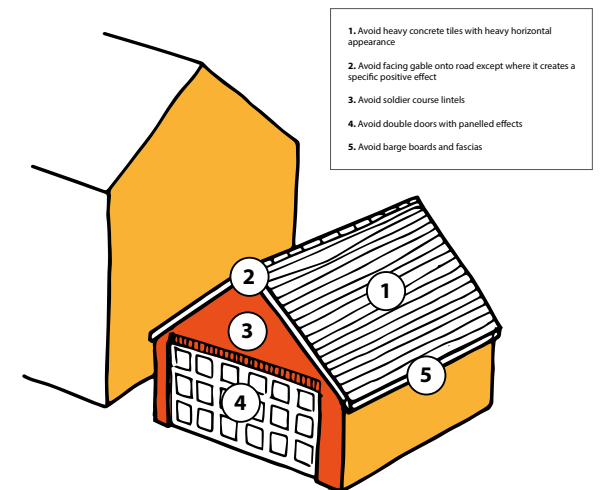
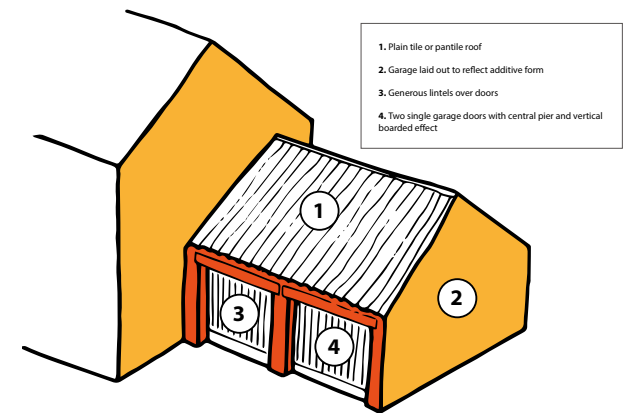



This house and garage are in harmony with one another



The impact of the double garage is minimised by the overall design of the building

Garage Design Measurements

- Minimum internal clear width as follows:
 - 3.3m if cycle storage is to the side of garage
 - 3.0m if cycle storage is to the rear of garage
 - 5.5m for double garage with no internal wall
- Minimum internal clear length 6m
- Minimum single garage door width of 2.4m
- Additional length preferable to provide sufficient space to allow options for storage of bicycles and bins.
- Separate personnel doors are encouraged to improve access when a vehicle is parked in the garage.

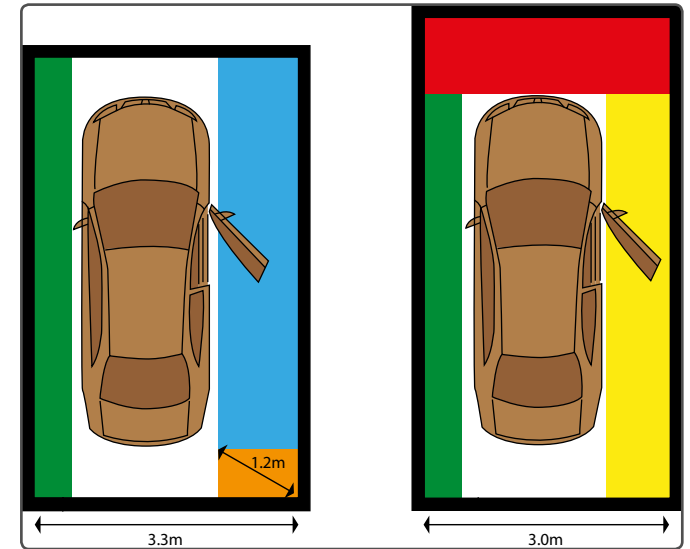

Figure 3.2.7 Garage design measurements (assumes no passengers)

Key

- Area to allow drivers car door to be opened, cycle storage and access (minimum with 1m).
- Area allocated to allow a vehicle door opening width (minimum width 700mm).
- Clear space to allow manoeuvring of vehicle (minimum width 400mm).
- Minimum circulation space required to allow access to cycles without the need to remove vehicles.
- Additional length for cycle storage dependant on the number and arrangement of cycles. Personnel door required to the rear of garage for access and manoeuvring of cycles.

B

H

←

→



- 3.1
- 3.2
- 3.3
- 3.4
- 3.5
- 3.6
- 3.7
- 3.8

Cambridge

Well designed structures in appropriate locations



Cycle Parking

To encourage cycle use, it will be necessary to provide secured covered cycle parking provision within all new developments in Huntingdonshire.

For housing, cycle parking should be provided within garages of suitable size (please refer to garage design section on pages 94-95) where provided. Where there is no garage, cycle parking is to be provided by way of a covered and secure structure within the domestic curtilage, such as a garden shed. For apartments, cycle parking should be provided within a covered and secure structure ideally designed in as part of the main building.

For offices, shops and all other non-residential uses developers must ensure that sufficient covered cycle parking is provided in convenient locations close to main entrances where it will benefit from natural surveillance for both staff and visitors. Separate secure cycle parking for staff use should be provided, ideally within in the main building.



Covered and secure cycle parking - Brampton

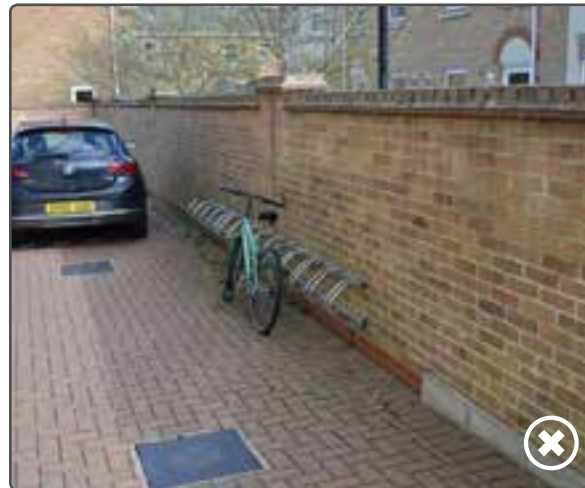

Poor cycle parking provision – St Ives





Cycle parking, Nightingale Mews, Huntingdon



Integral cycle and bin store, Bearscroft Farm, Godmanchester



Cycle parking at The Club building, Alconbury Weald



Integral cycle and bin store



Light and airy yet still covered and secure - Cambridge

Servicing for Residential Development

The storage and collection of waste and recycling from residential properties must be carefully considered as part of an integrated design solution.

Collection vehicles are likely to be the largest vehicles that will regularly use residential streets. Access for collection vehicles should be considered as part of the design of streets and the layout of buildings. The dimensions and turning capabilities of collection vehicles should be considered when deciding on details such as the design of junctions.

Where private drives are proposed they will need to be constructed to an adoptable standards if they are to be used by collection vehicles. An indemnity agreement will also be required. Alternatively a collection point will need to be provided, but this must not be more than 30m from where bins are stored or 20m from the edge of the adopted highway. The location of collection points should be carefully considered to ensure ease of access and the amenity of nearby residents, businesses and other users are not adversely affected.

B

H

←

The arrangement of on-street parking spaces, street trees, lighting columns and other street furniture can mean that access for collection vehicles is difficult so the position of these items should be considered. The design solution must not require any part of collection vehicles, other than wing mirrors, to overhang pavements or other areas adjacent to the carriageway.

Storage for waste and recycling can be provided either individually for houses or communally for flats or other high density developments. In all cases storage should be:

- designed with sufficient capacity to accommodate the applicable containers
- discreet when viewed from the public realm
- protected from weather and animal interference
- designed to enable ease of access to bins on collection day

Service access to the rear gardens for long runs of terraced houses should generally be via a built over alleyway or 'ginnel'. Commonly used in Victorian terraced housing for coal deliveries, this is now a very useful device for bringing out wheeled bins from back gardens.



Integral cycle and bin store, Nightingale Mews, Huntingdon



Bin store, Romans Edge, Godmanchester





This is good example - the single storey bin store has been incorporated into the building



This bin store does not hide the bins very well



A poorly designed bin enclosure



No thought has been given to where residents will store bins for this development in Huntingdon

This helps create continuous built frontages and a sense of enclosure. Long convoluted rear access alleyways will not be acceptable. Such alleyways can become disused and not maintained as residents keep their bins in front gardens or other areas which can adversely affect the amenity and appearance of the surroundings.

For flats and other high density developments communal storage bins can be used. Communal bin storage areas must be on the ground floor and should be well ventilated,

covered and secured with a door. They are often best designed as part of the main building structure. A dropped kerb should be provided so that communal bins can be collected easily. Collection points for communal bins must not be more than 10m from the edge of the adopted highway.

Further reading:

- [Cambridgeshire and Peterborough RECAP](#)
- [Waste Management Design Guide SPD](#)
- [Building Regulations](#)
- [Huntingdonshire Developer Contributions SPD](#)
- [Huntingdonshire Waste Collection Policies](#)

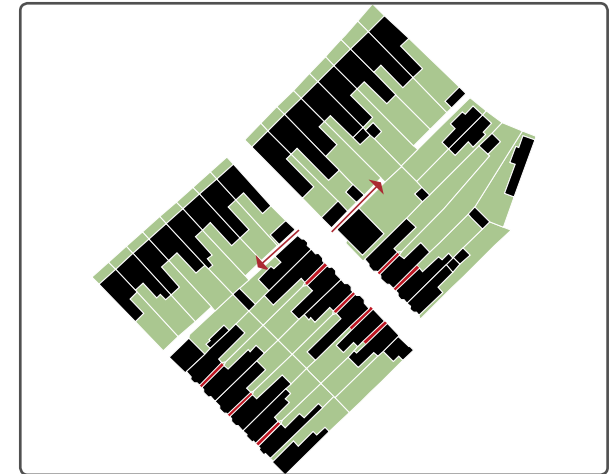

Rear garden access for terraced properties in Victoria Square access their rear gardens



This modern development uses a ginnel so that these terraced houses can access their rear garden easily



A built over alleyway for Victorian properties in Huntingdon

B

H

←

→

Servicing for Commercial and Office Use

Servicing, particularly for commercial buildings, must be carefully considered as part of an integrated design solution. It is important that any service yards are well designed and located.

Servicing can also be provided from the street in town and local centres by designing service bays managed and controlled with time restrictions to minimise any hindrance at busy times of the day. Where service bays are publically accessible, they should be designed with shared surface materials as an integrated part of the public realm to be used by pedestrians when not in use. Care should be taken when locating service entrances and service yards so that they do not dominate the building frontage.

Service yards must be appropriately screened by development or a high wall, and should incorporate landscaping both outside and inside.

- (B)
- (H)
- (←)

The sensitive location and design of plant ducting and machinery will be required. Plant ducting and machinery should not be able to be seen from public view, particularly if it is on the

roof. Plant and infrastructure which is crudely fixed to the external structure of the building will not be acceptable.

In some cases the design of plant ducting and machinery may be used as a feature as part of the architectural design of a building. This may include a design where the servicing of the building is located externally to the building's skin, to create visual interest.



This service road is overengineered and not pedestrian friendly



The attention to detail here is poor - the service area is a mess



This service area should not face onto the public realm



3.6 Landscape and Public Realm

The creation of high quality landscape and public realm is important in all new development, playing an intrinsic role in establishing a sense of place.

For the purpose of this guidance, landscape and public realm are divided into two categories:

1. Strategic scale: relating to larger scale developments where a clear landscape strategy needs to be part of a design brief and master plan.
2. Local scale: relating to all forms of development

All development must incorporate the following landscape principles:

- Landscaping and public realm should be interconnected to create a network of green infrastructure both within any site and to connect to wider routes and places.
- All public spaces should be clearly defined and designed to fulfil specific roles and functions for a range of users.
- Existing landscape features (such as trees and hedgerows) should be retained, enhanced and complimented by these new landscape elements where possible.

Landscape and public realm hierarchy

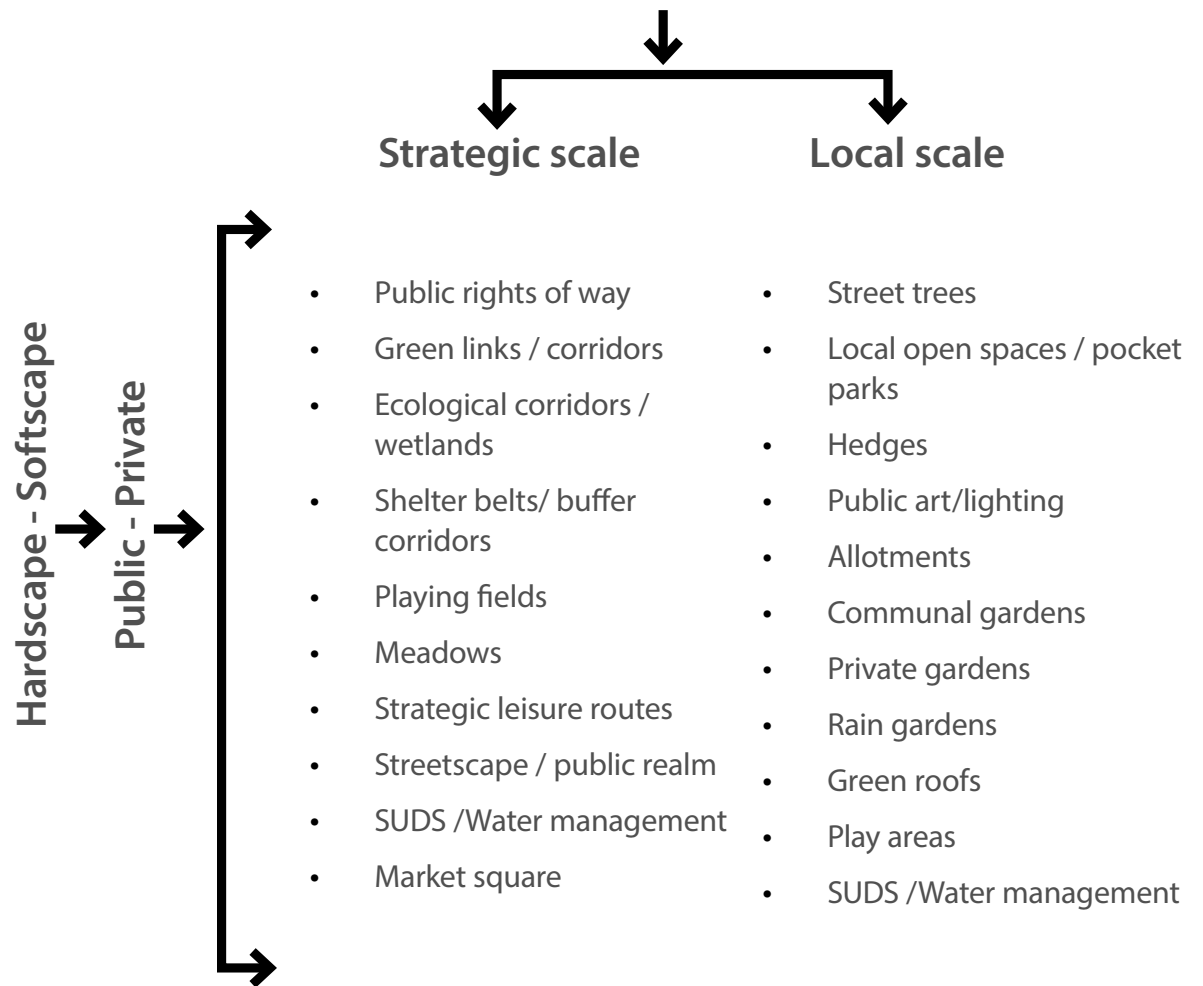

Strategic Scale Examples

- Public rights of way
- Green links/ corridors
- Ecological corridors/wetlands
- Shelter belts/ buffer corridors
- Playing fields
- Meadows
- Key open spaces/Neighbourhood park
- Streetscape
- Sustainable drainage systems
- Market square
- Riverside



Coneygear Park, Huntingdon



Priory Park, St Neots



Loves Farm, St Neots



Noble's Field, St Ives



Jesus Green, Cambridge



Market Square, St Neots

Local Scale Examples

- Secondary / tertiary streets
- Local open spaces/pocket parks
- Green edges
- Public art/lighting
- Allotments
- Communal gardens
- Rain gardens
- Green roofs



Robust hedgerow



Communal landscaping



A good amount of soft landscaping here



Allotments



Green roof



Rain garden



Wide path with trees creates an attractive environment

Strategic Scale

A landscape strategy should be an integral part of any larger scale development project. It should define the function and quality of spaces, the relationship with the existing areas of landscape and any proposed built environment.

Some key guidelines for developing a robust landscape strategy include:

- There should be a clear hierarchy of interconnected spaces, including: recreational uses, wildlife corridors, allotments and sustainable drainage areas (which has sufficient capacity to accommodate water in flood scenarios).
- New developments should be linked to surrounding areas using green corridors to assist wildlife movement as well as by a network of paths and bridleways.
- Create a cohesive landscape setting and a sense of 'belonging' within the wider landscape.

- A sensitive and respectful approach towards the local landscape character and topography must be considered from the outset of the design process.
- All public open spaces, parks and public realm should be designed to be inclusive with all age groups and abilities catered for. The local community should be engaged in this design process where possible.
- It is not acceptable for areas intended to be classified and used as open space to:
 - be comprised mainly or wholly of land which also doubles as a balancing area (which is likely to be unusable for at least part of the year);
 - be occupied by dense planting as part of buffer zones; or
 - be inaccessible to disabled people.



Figure 3.6.1 Green corridors

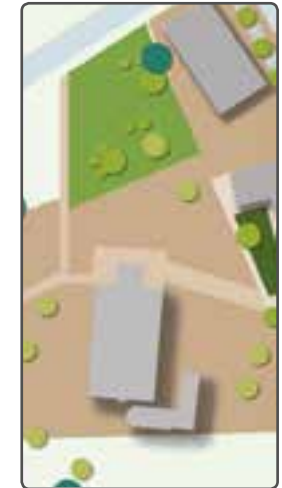

Figure 3.6.2 Green spaces



Figure 3.6.3 A network of routes

Existing landscaping features such as hedges should be retained.

‘Wet’ or ‘dry’ ecological corridors should be designed to retain existing habitat and wildlife and encourage creation of additional ecologically diverse habitats.

Site drainage patterns and an understanding of the natural flow of water is important in mitigating any flood risk issues.

Buildings adjacent to open spaces should try to be orientated along an east-west axis to reduce

the overshadowing of open spaces and to maximise solar orientation.

Trees play a fundamental part in shaping the landscape and providing protection from wind and sun. Deciduous trees planted near buildings help provide shade in the summer and allow heat to penetrate in the winter. Rural fringe areas exposed to prevailing winds should think about the use of planted shelter belts to ensure relief from wind.

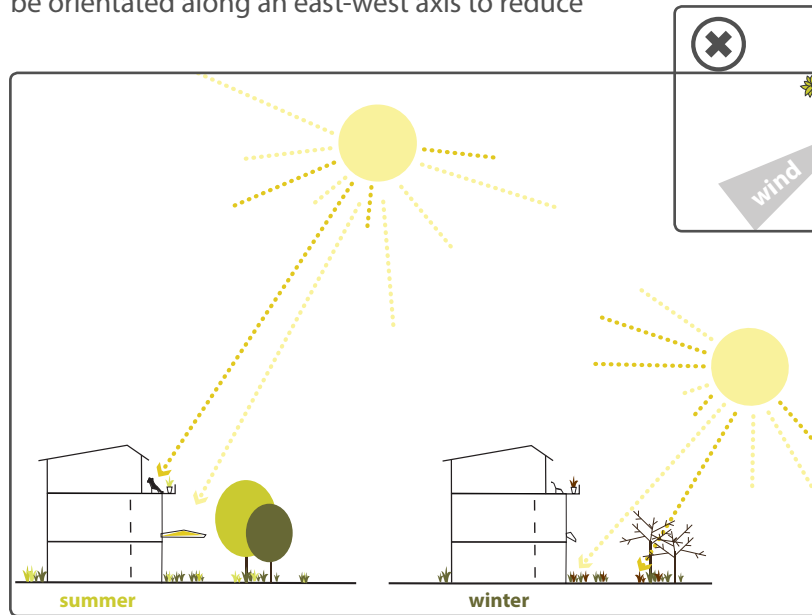

Figure 3.6.4 The effect of tree shading

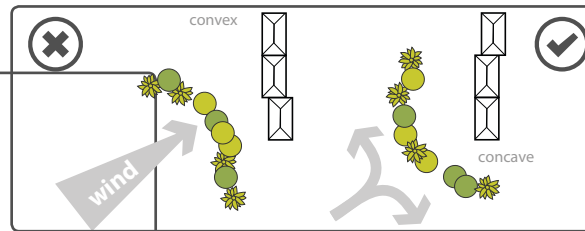

Figure 3.6.5 The effect of a shelter belt



Huntingdon, Cambridgeshire

Trees play a fundamental part in shaping the landscape and providing protection

Local Scale

At a local scale it is important that any landscape scheme works with the surrounding buildings and streets.

Key principles include:

- Landscape and public spaces should be enclosed by buildings in urban locations, although in lower density areas this enclosure can be less defined.
- Urban spaces should be surrounded by uses that provide overlooking for passive surveillance and the safety of users.
- For important local spaces lots of active frontages should be provided to enhance activity and supervision
- Recreational open spaces should be easily accessible by various modes of transport. Local parks should be placed within 5 minute walk (400m radius) of neighbourhoods (see fig 3.3.2 on page 44).
- Amenity spaces (parks, pocket parks, squares, allotments etc.) should be located within 250–400m catchment of the majority of homes
- High density and infill developments will need to be creative with space. Green roofs and roof gardens should be considered from the outset.
- General advice on devising appropriate planting schemes for different types of development, including recommended lists of species, can be found in the Cambridgeshire Landscape Guidelines (Cambridgeshire County Council, 1991).

For further reading use the following weblink:

Cambridgeshire Landscape Guidelines

B

H

←

→

Local Scale

Example 1. A local park designed with play areas overlooked by surrounding buildings providing surveillance. Designed as a mix of hard and soft surface treatments the park is within walking distance from residential neighbourhoods

Example 2. High quality shared surface treatment for home zone street with on-street parking

Example 3. Communal courtyard block with integrated play area

Example 4. Residential block with private garden screened properly to avoid any privacy issues

Example 5. A network of secondary informal pedestrian links connecting to riverfront.



Nature of Spaces

Areas of public realm can be soft or hard or a combination of both. In urban areas where the public realm is predominantly hard space with limited access to private gardens and soft landscaped spaces, more thought should be given to creating town parks or neighbourhood community gardens, as well as determining who will maintain these spaces.

Larger open spaces will provide for habitat creation, drainage and the provision of multifunctional amenity uses. In rural locations and the edge of towns and villages, there may be more emphasis on access to natural open spaces as well as a network of public footpaths.

High quality materials will contribute to the success of any space. They will also minimise maintenance and add to the longevity of the development.



The importance of detail



When no one is responsible



Public realm outside a cinema



Playing field



Town centre activity



Seating with interesting design



Office building central space



Nice detailing



Contrasting high quality materials



Robust soft landscaping

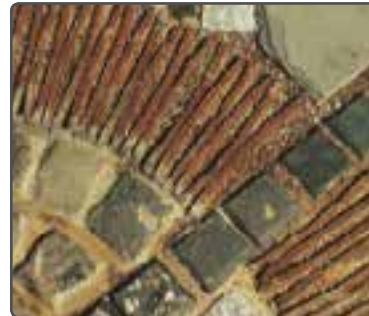

Interesting detailing



Subtle car parking detailing



Use of discrete public art detailing



Curb line, carriageway & pavement, in a sympathetic grey material palette



Huntingdon, Cambridgeshire

Play Spaces

Successful play spaces require careful thought and planning to ensure they provide the best possible play opportunities for children and young people. It is important to provide high quality play space in safe locations where children can meet in their local neighbourhood.

When designing a play space it is important to consider the sort of challenges and activities that children may want to take part in. Some elements of play activity are listed below and should be included in any play space design:

- Construction and destruction (e.g. dens, dams)
- Creative play with sand, mud and other loose materials
- Physical games and informal sport
- Exploring nature and the elements
- Social interaction or ‘hanging out’
- Balancing, swinging, sliding, climbing and hiding
- The provision of playgrounds should always be undertaken in consultation with children and parents.

- All ages and abilities are able to play together

The design and provision of play space must take into account the principles set out in the document entitled ‘Planning and Design for Outdoor Sport and Play’ published by Fields in Trust.

HDC has standards for play space for different scales of development within its *Developer Contributions SPD*.

Further reading: www.fieldsintrust.org



Figure 3.6.6 Buildings should overlook play areas



Modern durable play equipment



Playground as public art



Playground as landscaping

Ecology and Green Infrastructure

Many people in urban and town centre environments are increasingly disconnected from nature. It is now widely accepted that people’s connection with nature and green open space can increase their health and well-being. Thinking about nature should be one of the starting points of good planning and is an essential component of delivering sustainable development.

Developers are encouraged to discuss with the Council as early in the development process as possible, in order to establish the potential ecological impacts of a proposal, and the opportunities it may present to enhance biodiversity and the local and strategic green infrastructure network.

Understanding the assets, functional requirements and potential benefits of the existing green infrastructure is fundamental to the context of any development. The ecological function of existing green infrastructure as habitat networks can be protected and enhanced through careful planning, and this in turn can lead to improved public access to green infrastructure and all the benefits this can bring to all ages.



The five main ecological objectives that can be achieved through the planning process are:-

1. Protect current habitats and species
2. Enhance existing habitats and create new areas
3. Mitigate against potentially damaging impacts
4. Compensate where damage is unavoidable
5. Monitor and enforce to assess the success of enhancement, mitigation and compensatory measures.

Even if there are no statutory designations affecting a site it may well be appropriate to carry out a Preliminary Ecological Appraisal (PEA). This would indicate, for example, the likely significance of ecological impacts on a proposed development site, and/or whether protected species are present and will be an important contribution to early discussions between developer and planning authority.

Further reading:

[Landscape Institute Public Health and Landscape](#)

[Landscape Institute Future of Cities](#)

[PEAs Technical Guidance](#)

[Cambridgeshire Green Infrastructure Strategy](#)



Bug Hotel





Alconbury Weald, Cambridgeshire



Trees

Trees matter. While over 80% of the UK’s population live in urban settings, trees in and around built-up areas have become a key component of the infrastructure that makes places work, look and feel better.

Trees are part of the solution to challenges from climate change to declining health and well-being. Trees restore the environmental and social balance in our neighbourhoods and town centres, contributing to the conditions for economic success.

All opportunities to increase the overall tree cover in Huntingdonshire should be taken and tree planting should always be considered. Particular instances include streets, verges, pavements, carparks, parkland, open space of various sizes and sustainable drainage systems.

Successful tree planting is always more likely to be achieved when it is carefully planned to work in conjunction with parking and street lighting.



Trees on development sites

The British Standard 5837: 2012 ‘Trees in relation to construction – Recommendations’ should be the principal reference document when considering new and existing trees on proposed development sites.

When considering proposals for development, it is important to consider the effect they may have on existing trees, and to explore the opportunities for new planting.

Existing trees should be considered at the earliest design stage to allow them to be successfully integrated into new development.

Development layouts should be designed to ensure that retained and existing trees are able to grow and mature in the space provided.

To integrate existing trees into a proposed development successfully, it will be a planning requirement to allow enough space in the design to enable new and existing trees to mature and flourish without outgrowing their surroundings and not dominate adjacent new structures or create apprehension for new

residents. Protection measures for existing trees will also be required during the entire construction phase, including demolition.

Where developments are likely to affect existing trees on and off the site the Council will require the submission of a detailed tree survey, including an Arboricultural Impact Assessment to assess potential impacts and propose mitigation as appropriate. The recommendations of the tree survey should be based on the condition and value of the trees as they are, and NOT on a preconceived layout for the site.

Development layouts will not be acceptable if they would result in undue pressure for future felling or unsightly heavy pruning.

It is equally important to plan for the planting of trees on development sites that have no existing trees. Section 197 of the Town and Country Planning Act 1990 places a duty on the Local Planning Authority to secure the planting of new trees, and the following factors should be considered when planning a tree planting scheme:

B

H

←

- Adequate space should be allowed for planted trees to reach their mature height and spread without causing

nuisance to built structures and their occupants.

- Suitability of planting positions, tree species and specifications in proximity to adjacent constructions, such as walls and buildings, to avoid the risk of structural damage/future maintenance as trees grow and mature. The opportunity for smaller ornamental trees within front, side and rear gardens is encouraged when visible from the public realm.
- The location of new and existing lighting columns and underground infrastructure should be considered in parallel when considering the location of new trees to avoid conflict and future maintenance issues.
- To enable trees to reach their optimum size, a sufficient soil volume will need to be available to the root system.
- Early engagement with Cambridgeshire County Council is encouraged with regard to the adoption of trees within the highway. Trees that abut the highway/within the highway (but are maintained by others) will need to be planted in appropriate tree-pits to CCC specification



Retained tree in Huntingdon

Further reading:

Trees and Design Action Group – Trees in the Townscape, A Guide for Decision Makers

HDC Tree Strategy

Landscape Institute - Profitable Places

→



Trees retained in a new development



Trees in the street



Incorporating existing tree into new development



New trees planted in a business park setting



Street trees in verges

B

H

←

→

Flood Risk & Water Management

Flood risk and water management must be considered from the outset of the design process. Flood risk can have a significant impact on the design of new development. However, if flood risk is considered at an early stage it can be appropriately mitigated for with minimal impact on design.

It is important that all developers consider how the management of water can be achieved. Sustainable drainage Systems(SuDS) will affect the design and layout of the proposal and the overall density of development. Effective SuDS and water management strategies can provide many benefits including:

- Reduced surface water runoff to mitigate flood risk and erosion
- Improved amenity and integration with open space
- Improved water quality
- Local water resource to supplement potable water use
- Biodiversity enhancement



Various ways to integrate water management	
1	Urban square with permeable paving
2	Retention pond with integrated seating
3	Rill within pedestrianised shopping street
4	'Brown' roofs within town centre
5	Planted roadside bio-retention strips
6	Detention basin/infiltration trench
7	Green roofs
8	Segmented micro-wetland within courtyard
9	Filter strip and retention pond within residential street/mews
10	Permeable paving within residential street/mews
11	Roadside bio-retention tree pits
12	Large, naturalised swale within green space
13	Wetland areas
14	Natural waterway
15	Rainwater butt



Figure 3.6.7 Water management



Sustainable Drainage Systems

Understanding the site topography, including natural drainage paths, existing water bodies and potential infiltration areas are important for new developments. Design principles for water management include:

- Clustering similar land uses as this can ensure that the level of treatment is consistent and more efficient.
- Maximise permeable areas through the use of green infrastructure and permeable paving to help reduce runoff and recharge the groundwater, subject to ground conditions
- Allocate sufficient space for SuDS (on a site by site basis) – 5-10% of the site is a reasonable initial estimate
- Rainwater harvesting may be integrated at the individual building scale. Other common practices include the provision of green roofs and walls which hold back water while also providing amenity and biodiversity benefits. Constraints will also need to be considered, such as the underlying geology and soil types.



Green roof



Green wall



Water butt - rainwater harvesting

Sustainable Drainage Systems (SuDS)

Rainwater Harvesting **Description**



Rainwater is collected from the roof of building and stored in an overground or subterranean tank for treatment and re-use within the plot.

Green Roofs / Walls **Description**



Soil and plant material is attached to the roof or walls of a building to create a living surface. Water is stored in the soil layer and absorbed by vegetation.

Swale / Filter Strips **Description**



Shallow depressions designed to convey and filter water. These can be 'wet', where water gathers above the surface, or 'dry' where water gathers in a gravel layer beneath. Surface can be vegetated. may be lined or unlined to allow infiltration. Often used alongside roadways.

Permeable Paving **Description**



Paving which allows water to soak through. Can be paving blocks with gaps between solid blocks or porous paving where water filters through the block itself. Water can be stored in the sub-base beneath or allowed infiltrate in the ground below.

Attempts to reconnect the water cycle should also be made. Opportunities to reuse water should be considered. While these can be done on an individual building scale, they become more economically viable when done at a site-wide scale.

Wherever possible sustainable drainage systems and permeable surfaces should be incorporated along new streets, subject to discussions with the Council and suitable ground conditions.

Further reading:

[Construction Industry Research And Information Association \(CIRIA\): Susdrain](#)

[Cambridgeshire Flood and Water SPD](#)

[Flood resilient construction of new buildings](#)

CIRIA & National Standards

HDC Water Cycle Study Stage 2



Drainage channel following pedestrian route



The landscaping has taken alongside the stream



The stream is canalised at this point

Bio-retention



Description

A vegetated area with gravel and sand layers below designed to channel water vertically to filter and cleanse. Water can infiltrate ground below or drain to a perforated pipe.

Hardscape Storage



Description

Hardscape water features can be used to store run-off. These can be integrated into public realm areas with a more urban character.

Wetland



Description

Wetlands are shallow vegetated water bodies with a varying water level. specially selected plant species are used to filter water. Water flows horizontally and is gradually treated before being discharged.

Pond



Description

Ponds can be used to store water. 'Wet' ponds have a constant body of water and run-off is additional, while 'dry' ponds are empty during periods without rainfall. Ponds can be designed to allow infiltration to ground or to store water for a period of time then discharge.

Lighting

Street lighting should be decorative as well as functional. Careful consideration of street lighting should seek to:

- Enliven the whole of the area in a visually coherent and interesting manner
- Encourage creative thinking in the use of street, building and advertisement lighting within town centres
- Ensure that the town and village streets and spaces are sufficiently well lit to promote personal safety
- Ensure that lighting provision between adjacent developments is coordinated to reduce clutter
- Consider attaching lighting to buildings so as to reduce clutter (however liaise with Conservation colleagues regarding attaching lighting to heritage assets).
- In predominantly pedestrian spaces use lighting which is appropriate and does not overwhelm the space



Street light in a good location



Street light attached to building to reduce clutter



Private lighting in car courtyards or roads that will not be adopted by the County Council

Exterior Lighting levels - design considerations

Car Courtyards are semi-public areas used primarily for parking and access to adjacent properties. These areas should have appropriate lighting for pedestrians to be seen by drivers, who can also see and be seen going to and from from parked cars.

It is important for there to be facial recognition of people in these areas. This can be achieved by the designed lighting being mounted at a height of 4-5m. The luminaires should be mounted horizontally (0 degrees tilt), so no upward light is generated. Luminaires with an Upward light Output Ratio (ULOR) of zero will achieve this criteria. Bollards are unacceptable as a primary source of lighting, as to achieve facial recognition would require the bollard lighting to be directed upwards, which would cause obtrusive light.

The vehicle speeds are slow and consequently the lighting in these areas

need to be uniform but can be relatively low.

Design Standards

There are two standards that make recommendations for lighting levels of areas with mixed vehicle/pedestrian usage. These are BS EN 13201-2:2003 and BS 5489-1:2013.

The use of these standards and any associated design should be done by competent lighting designers.

The design criteria is for horizontal illuminance. Care should be taken by the lighting designer to minimise the amount of light going into windows of adjacent properties and if it appears that this may be the case, vertical illuminance calculations may be required.

Lighting class P5 would generally be appropriate for lighting design purposes. Average maintained illuminance (Eav) = 2 lux
Minimum maintained illuminance (Emin) = 0.4 lux
This give a minimum Uniformity of Illuminance (Uo) of 0.2

Choice of light source

There have been advances in exterior lighting, which includes LED (Light emitting Diode) becoming a viable alternative to other forms of lighting -High Pressure Sodium (SON), metal halide and fluorescent. LED have low energy usage and very low maintenance requirements and are probably the best choice for car courtyard lighting

Designs submitted for planning consideration should have the following information.

Luminaire name and manufacturer, tilt angle (normally 0 degrees), light source type within the luminaire eg LED, Mounting height, Design lighting levels (Eav, Emin and Uo), Isolux contours to 0.4 lux. If LED is used as the light source the colour temperature should be provided. Normally a colour temperature of 2700-3000 degrees Kelvin (warm white) should be used.

B

H

←

→

Public Art

Public art is increasingly being recognised as a crucial element in the creation of successful public spaces in our towns and cities. It helps to increase investment values, provides a creative edge and adds that vital ingredient of fun.

Public art may be appropriate in a range of locations including but not limited to: streets, bridges, landmark buildings, public spaces and land form.

It can take the form of large scale interventions such as earthworks, and small scale interventions such as interesting seating or paving in the public realm.

Large scale major development proposals should include strategies for the provision of public art through the life of the development.

Further reading:

www.publicartonline.org.uk



Entrance Gates to Nightingale Mews, Huntingdon



Railings and gates fronting Brookside, Huntingdon



Public Art within Huntingdon Multistorey carpark



Street Furniture and Signs

Care should be taken to ensure that street furniture and signage does not “clutter” the public realm or block routes and desire lines. Clutter is unattractive.

The following principles should be incorporated into the design of street furniture:

- Materials should be long lasting and easily maintained with components that are easy to replace
- ‘Visual clutter’ should be reduced and street furniture should be integral to the overall landscape and public realm design
- Street furniture should try to use a consistent materials palette
- Designers should start from a position of having no signs, and street layout should aim to make the environment self regulatory
- The Traffic Signs Manual states that it is ‘desirable to limit the number of posts in footways. Where possible signs should be attached to adjacent walls.’

Applicants and developers will be expected to discuss these matters with the Council as planning authority as well as the county council as highway authority.

For further information use the following weblink:

Traffic Signs Manual



Good example in Cambridge



A lack of coordination in St Ives



Huntingdon, Cambridgeshire

Street furniture should try to use a consistent materials palette

Street names are obviously important in helping people find their way around places.

The location of street name plates is an important element in this regard and where possible street name plates should be attached to walls, either on boundary walls and fences, or on buildings. This also helps to de-clutter the street.



Street names attached to wall, Bradury Place, Huntingdon



Street names attached to wall, Temple Place, Huntingdon



Street clutter at St George Street, Huntingdon



The location of street name plates are important

Huntingdon, Cambridgeshire



Shop Fronts

Shop fronts have a significant impact on the character and attractiveness of our town centres. Shop front design is about presenting goods in as appealing a way as possible, but it is also important that the shop front respects the building in which it is situated.

Each street has a character and visual hierarchy that is established by the relationship between the buildings found there.

If a shop front is to be successfully integrated into its surroundings, it will be required to respond to a number of established design criteria.

Shops must provide active frontages. This means lots of windows facing onto the public realm. Inactive frontages in the form of solid walls or dummy windows and façades will not normally be acceptable in most locations.

Proposals for shop security should be considered during the design stage and not as an afterthought. Any security measures should be an integral part of the shop front design and should endeavour to provide the least visually intrusive measures. Solid external shutters have a negative impact on the whole street and will not normally be acceptable.



Characterful shop fronts in St Ives



Beautifully proportioned shop front - Wansford



Sympathetic colours and signage to shop front which successfully turns the corner, High Street, Huntingdon

B

H

←

→

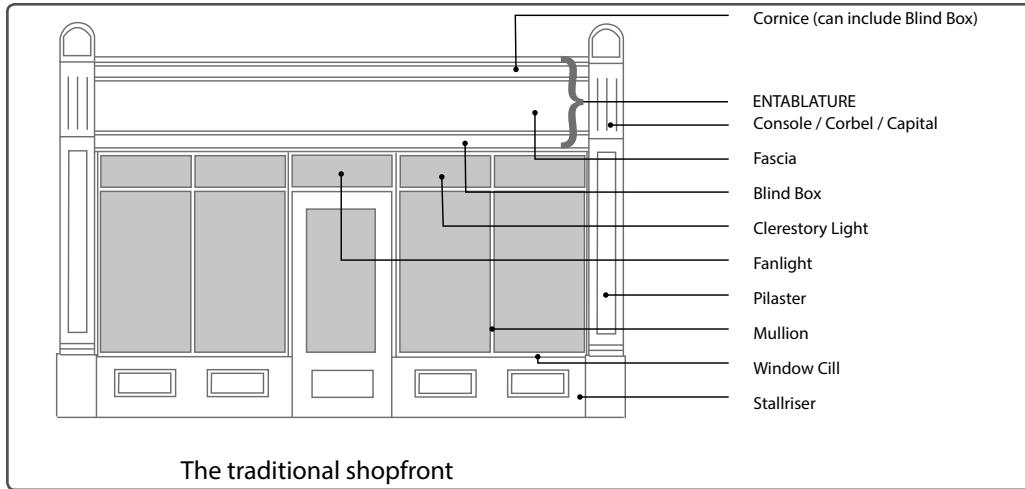

Figure 3.6.8 Traditional shop front

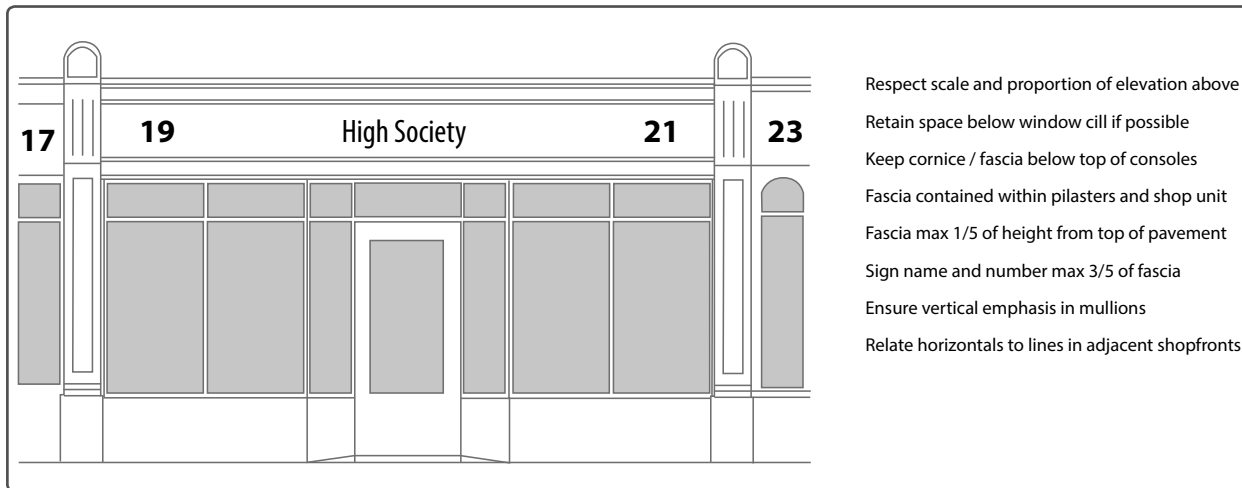

Figure 3.6.9 Modern shop front respecting traditional elements



Huntingdon, Cambridgeshire

Shop Front Activity

Shops and other uses such as offices and warehouses should provide active frontages where the building faces onto the public realm, helping to create an active and lively place.



The front of this shop mostly consists of inactive space - St Neots



Sympathetic hanging shop sign to shop frontage, town centre, St Ives



Well proportioned and lively front elevation to this shop - Ely



Active frontage - Huntingdon

3.7 Building Form

The shape, size and orientation (the form) of a building can have a significant impact upon its surroundings.

Traditional building forms enhance local distinctiveness and it is important to take these traditional forms, materials and general design principles into consideration when undertaking any development. Such building forms can produce attractive compositions (both traditional and contemporary) and can sit comfortably within their surroundings.

Buildings within development blocks or parcels must be configured and oriented to achieve positive internal and external spaces. This can be achieved by both buildings and landscaping. In principle buildings should respect a common building line determined by the required setback and character for that street or space.

Additionally new building form should allow for connections and links to be created with

adjacent development, especially in an urban context. This can create a series of informal routes and spaces which gives charm and interest to places. This is evident in many instances in Huntingdonshire.

B

H

←



Old Weston, Cambridgeshire

3.1

3.2

3.3

3.4

3.5

3.6

3.7

3.8

→

Building Form

The form of new buildings should generally reflect traditional building forms found in Huntingdonshire.

The basic house plan is the simple rectangular form that characterises most of the older dwellings in Huntingdonshire. These ‘wide frontage/shallow plan’ properties are typically no more than 4.5 to 6 metres deep, with a simple pitched roof spanning the narrow dimension.

This basic form is a feature of both simple vernacular cottages (of 1 or 1.5 storeys, usually having a ‘long and low’ appearance) and of more formal, higher status dwellings (typically of 2 or 2.5 storeys).

Traditional building forms reinforce the following design principles:

- Produce attractive building compositions
- Ensure that a new building sits comfortably within its surroundings
- Promote a sense of ‘local distinctiveness’
- Conserve energy
- Create homes that are relatively easy to adapt or extend over time

These general principles are derived from domestic building traditions found in the district, and should inform the design, whether the appearance is traditional or contemporary.

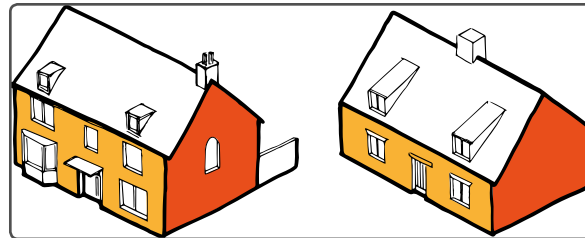

Fenstanton



Narrow span dwelling



Generous plots with deep windows and good use of render

(B)

(H)

(←)

(→)

As well as echoing local building traditions, this plan type offers distinct advantages for securing more 'sustainable' development, in terms of minimising resource use and producing buildings that are adaptable and long-lasting.

This is because:-

- it enables good penetration of daylight and sunlight as such buildings are often no more than one room deep, which also permits natural through-ventilation
- it is suited to steeper roof pitches, increasing the scope to utilise the roof space for accommodation
- the width of the plan makes it relatively easy to add extensions at the rear

This wide frontage plan can also respond flexibly to the characteristics of specific site layouts: it can be terraced, 'cranked' or 'curved' to turn corners, and it can follow contours in a series of 'steps'.

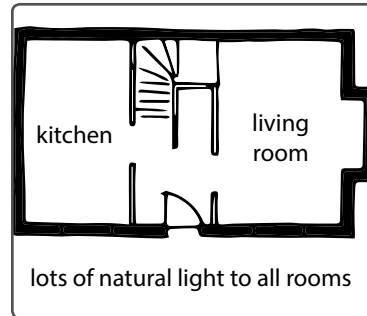

Fenstanton, Cambridgeshire

- 3.1
- 3.2
- 3.3
- 3.4
- 3.5
- 3.6
- 3.7
- 3.8

Larger and more complex properties can be created through additions to the rear or side of the basic rectangular form; such ‘additive’ elements are a common feature of vernacular buildings, but should be subservient in scale to the principal structure, maintaining its dominance within the overall composition.

Extensions to the front of the property should be avoided as building out from the frontage creates an unbalanced façade and disrupts the line of the street. Traditional houses in Huntingdonshire tend to be ‘flat-fronted’.

In some situations due to the site’s context, the building density or the building composition may require the use of narrow frontage/ deep plan forms. There are precedents for narrow-frontage forms in some of the district’s traditional housing stock (notably the Victorian terrace). When terraced with other units, narrow-frontage properties also enable good heat retention (due to limited external wall areas) and can make good use of land.

B
H
←

However, the narrow frontage/deep plan form performs less well in terms of natural lighting and ventilation, and is less adaptable than the wide-frontage type. Where narrow-frontage forms have to be used, plan depth should be

kept to a minimum. Care must be taken to avoid large and uninteresting end-gables. Often this can be done by using narrower units to shield the gable end, either in-line or at right angles.

For employment areas in more rural locations, buildings based upon typical farmyard arrangements offer good examples to follow in creating building structures that reflect local distinctiveness.

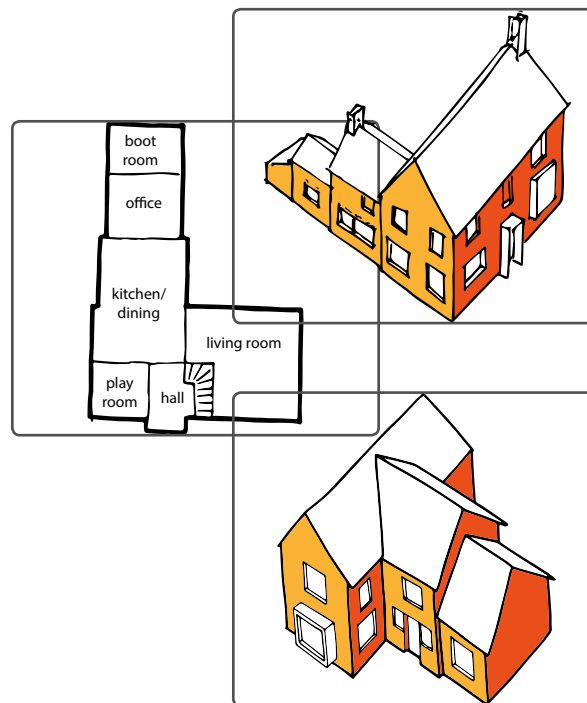

How to use additive elements



Small scale local employment development



View from the street



Medium density - Loves Farm

→

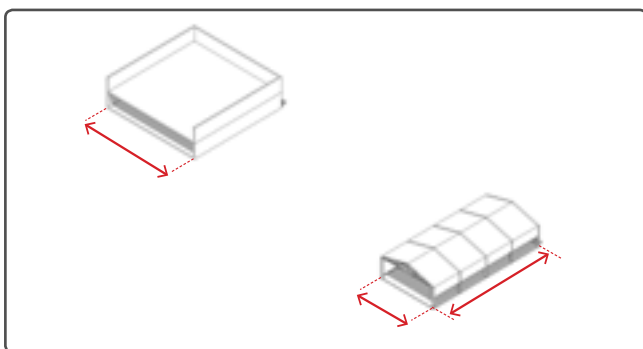
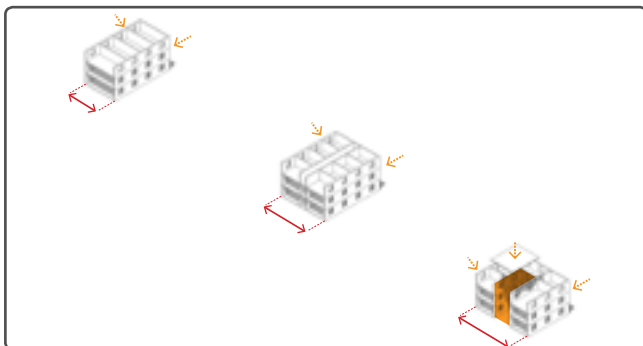
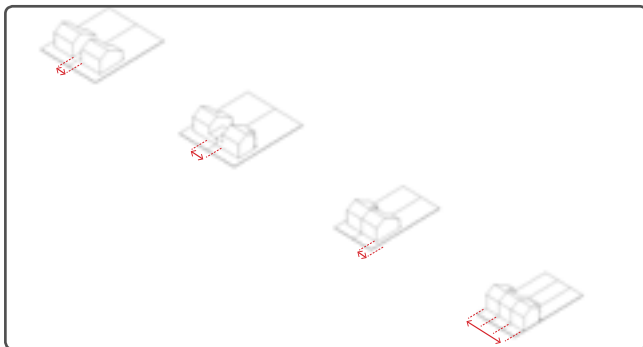

Type	Use	Typical Dimensions	Ground Floor Height	Typical Floor Height
Detached housing	Residential	Gap between two houses: Min. 2 - 6m. Min. 3m internal garage dimension	2.7 - 4m	2.7 - 3.2m
Semi-detached housing	Residential	Gap between two houses: 2 - 6m	2.7 - 4m	2.7 - 3.2m
Terraced housing	Residential	Gap between two houses: None	2.7 - 4m	2.7 - 3.2m
Apartments	Single aspect residential	6 - 12m building width	2.7 - 3m	2.7 - 3.2m
	Dual aspect residential	9 - 16m building width	3 - 5m	3 - 4.5m
Office	Single aspect office	6 - 12m building width	3 - 5m	3 - 4.5m
	Dual aspect	9 - 18m building width	3 - 5m	3 - 4.5m
	Atrium	16 - 30m building width	3 - 5m	3 - 4.5m
'Big Box'	Cinema, warehouses, retail, industrial use	-	-	-
Mixed use	Ground floor retail with office or residential above	Retail: Min. 12m deep with proper servicing facilities	3 - 5m	2.5 - 4.5m
Hotel	Hospitality	15 - 20m building width	4 - 6m	2.7 - 3.5m

Building Form - Balance and Harmony

There are many examples throughout the district and elsewhere within Cambridgeshire where buildings have been designed with a satisfying balanced composition. Such composition is pleasing to the eye and does not necessarily need to be symmetrical. Terraces, semi detached and detached dwellings can all demonstrate this feature in the hands of a good designer.



Balanced elevations - Histon



Balanced elevations - Huntingdon



A balanced composition is pleasing to the eye

St Neots, Cambridgeshire



These new detached houses have a harmonious relationship



Balanced semi-detached houses - Leighton Bromswold



A well balanced terrace of 'wide frontage, shallow plan' properties - Ramsey

B

H

←

→

Building Scale and Massing

The scale, massing and height of any proposed development should be considered in relation to that of adjoining buildings; the topography; the general pattern of heights in the area; and views, vistas and landmarks. Generally, the notion that the scale of buildings should relate to the width of the street, or the extent of open space in front of them, is a good rule of thumb. If you are going to break these principles, there should be a design rationale behind it, and it should be based on an evaluation of the impact that a particular arrangement of buildings and spaces will have on the character and sense of place.



Different scale, mass and articulation, Field Lodge Care Home, St Ives



Good enclosure through 3 storey scale around public space



Earith, Cambridgeshire

Ensure satisfying relationships with topography; heights; views, vistas and landmarks





The variety in scale provides a pleasing backdrop to the town - Godmanchester



Each building is of a different height to its neighbour - Kimbolton



Changes in scale - Brampton



Tall buildings can help to create a sense of place - St Ives

B

H

←

→

Building Articulation

Articulation is a useful architectural tool to break up or enliven a building facade and to reinforce a horizontal or vertical emphasis. As well as adding interest to residential buildings, this can also be helpful when trying to break up the mass of larger residential or commercial buildings.

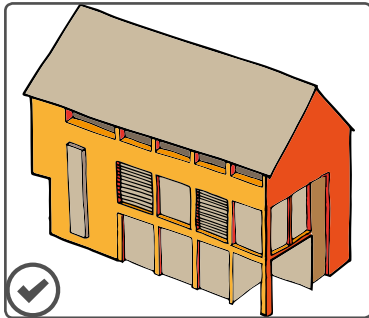

Interest to front and side elevation

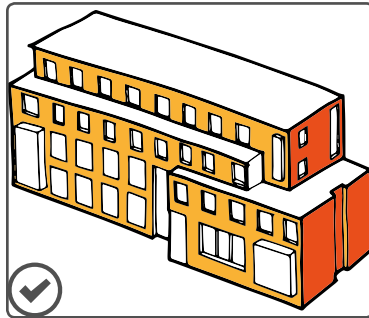

Variety of building composition, set back and height



Longsands College - St Neots



Brampton

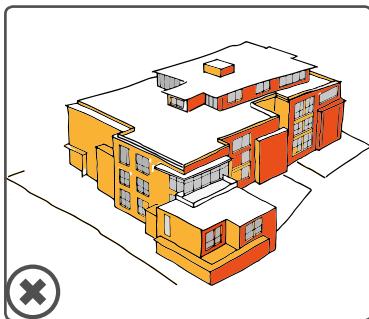

Overly large single storey projection at odds with the rest of the building

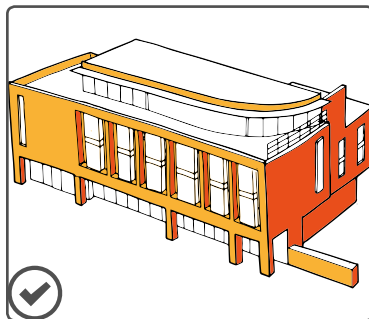

Detail added to the roof

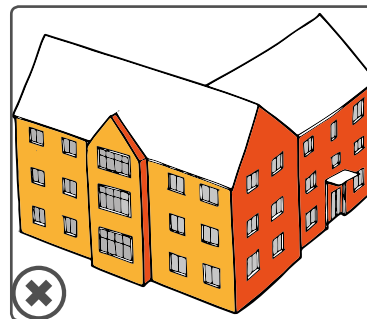

Location of door not on front elevation



New hotel - Cambridgeshire

Buildings turning a corner

An important townscape principle is for buildings to satisfactorily address the corner. There are various ways of dealing with this principle. Here are four common approaches used in residential development.

Option 1 shows full building frontage to both sides of the block, and can be achieved by the use of apartment blocks or by a special building design.

Option 2 is the more common design approach, with the gable end of the terrace or semi detached house facing out onto the corner. The preference is for the main entrance and habitable room windows to be in the gable, creating activity. This building will also have greater presence and may be taller than neighbouring buildings.



Hemingford Grey

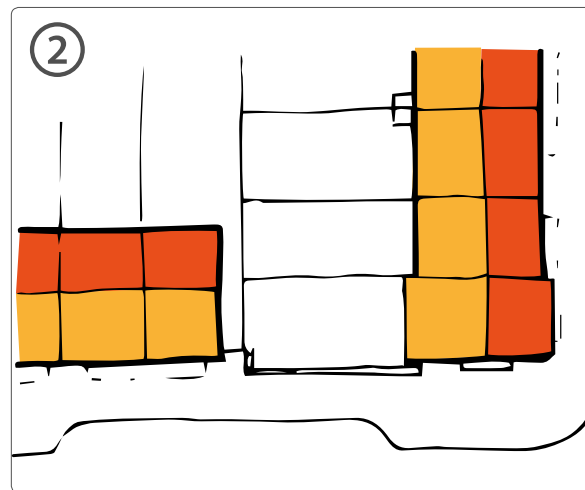

Huntingdon

Option 3 provides continuous built frontage to both streets at a corner through the use of a series of linked cranked dwellings in a convex arrangement. Problems may occur if the houses are too narrow as they may result in small rear gardens. The use of wide frontage cranked dwellings in this arrangement is encouraged.

Option 4 provides cranked dwellings through a concave arrangement, creating the opportunity for public open space to the front at the junction of the two streets.



Option 3

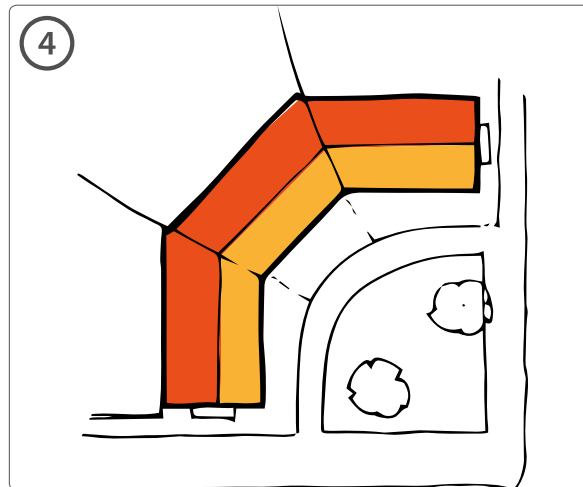

Option 4

It is important that all non-residential development including commercial and office development takes advantage of opportunities to address both streets when located on a corner site. There are a number of ways this can be achieved through building articulation, scale, massing and materials.



The emphasis on the corner of the building helps to identify the entrance - Ely



This office building accentuates the corner - Alconbury Weald



Dual aspect frontage at the mixed commercial development - Loves Farm, St Neots

Delight

Some buildings just delight. They often have a wonderfully simple relationship with the landscape around them. The buildings often have a pleasant simplicity themselves, proving that it is not necessary to design and build complicated structures to delight us.



Hilton



Wennington



Key building, Loves Farm, St Neots



Brampton, Cambridgeshire





Key building - Loves Farm, St Neots



Old Weston



Broughton



Brampton



Brampton, Cambridgeshire

Privacy and Defensible Space

The relationship between buildings and the space around them presents challenges in defining what is public and what is private. Appropriate privacy measures must be taken to avoid overlooking from streets, private and communal gardens, courtyards and open spaces into predominantly residential dwellings. This may also be necessary for office buildings.



A low brick wall helps create some defensible space - Colne



Setting the car parking away from the office building helps to create a pleasant working environment - Huntingdon



This new development incorporates some robust planting - Cambridge



it is important to get the relationship between buildings and the space around them right

Cambridge

B

H

←

→

Most residential environments comprise of a mix of public, private and communal spaces. It is important to clearly define the boundary between these spaces in order to provide clear ownership and responsibility for all open areas around new development and increase privacy and security to the home. Privacy between buildings and streets should be achieved by creating a 'defensible space'.

This is achieved in a number of ways:

1. creating landscape barriers using hedging, boundary fences or setbacks. Minimum defensible space should be 1m deep.
2. establishing a continuous restricted zone at least 1m deep along the pavement immediately adjacent to the property to prevent individuals from walking or standing immediately alongside windows. This area can be landscaped.
3. residential units with back-to-back gardens or opposite each other in courtyard blocks must have appropriate distances between them. A general rule of thumb of 21m distance between properties ensures privacy for residential use.

In all instances, building 'fronts' should face

the street or mews and 'backs' towards back gardens or courtyard. This principle will improve security, give privacy to units and provide visual interest in the streetscape.

Where limited setbacks are proposed such as new streets, the privacy between the fronts of dwellings opposite each other fronting a street can be created through staggering the dwellings and ensuring that windows to habitable rooms are staggered opposite each other so that direct overlooking is not possible. This is particularly relevant for first floor bedrooms.



Staggered first floor windows to avoid direct overlooking

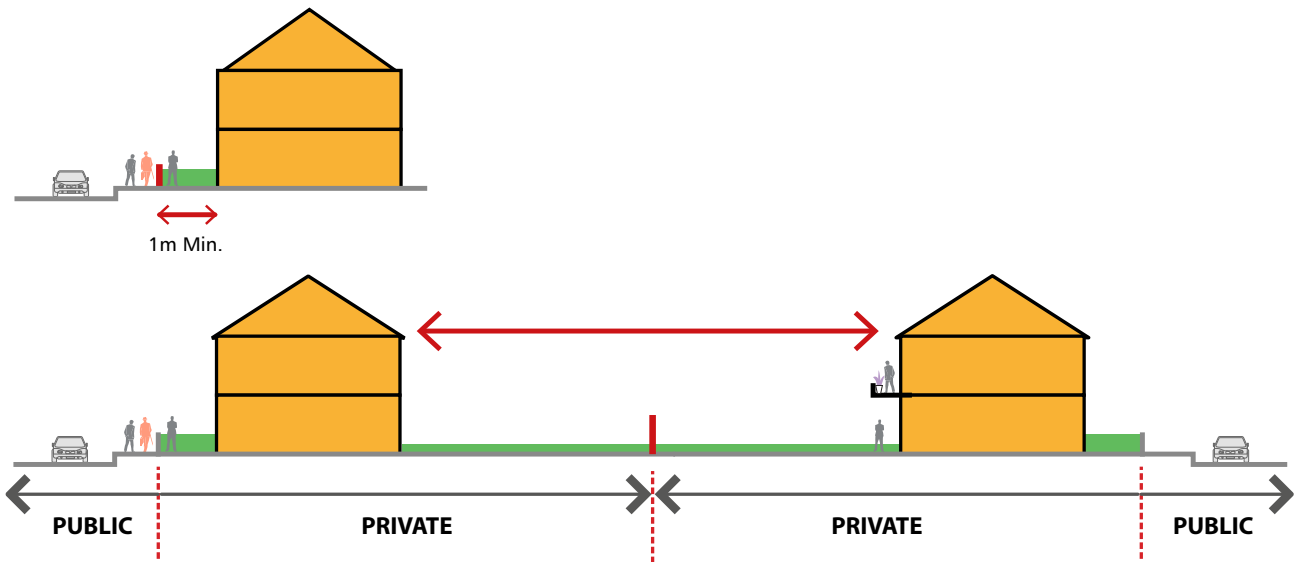

Defensible space in front of houses

Building Extensions - scale and proportion

Extensions should complement the form and character of the existing house, but this does not mean that it has to match the existing house in terms of materials or architectural design.

Overlarge extensions that appear to swamp the original building should be avoided, although a house can be extended significantly over time, and this can sometimes change the character of the dwelling in an acceptable way

Extensions to the front of houses should be avoided as they could compromise the visual cohesion of a building's facade.

There are any number of alternative arrangements when deciding how to extend a house. The following photographs and drawings show various successful approaches.

It is important to consider the amount of remaining amenity space in conjunction with the extension to the dwelling. This should be proportionate to the size of the extended property and in keeping with the established grain of development in the locality. The overdevelopment of sites is unlikely to be supported.

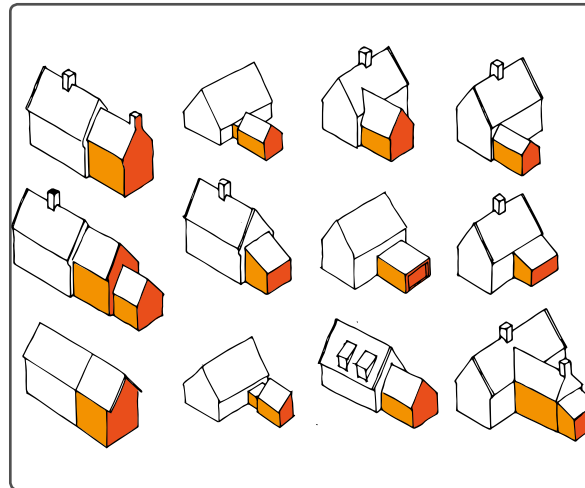

Different ways of extending your house

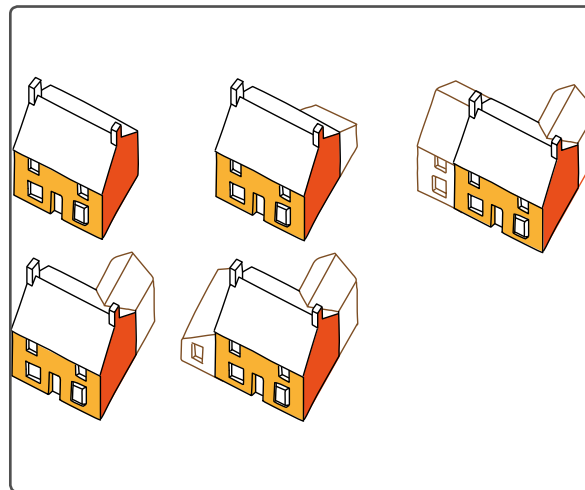

Extending a house over time





This extension broadly follows the original building line but with a very small set back - Brampton



Interesting side extension to a house, making maximum use of the available space

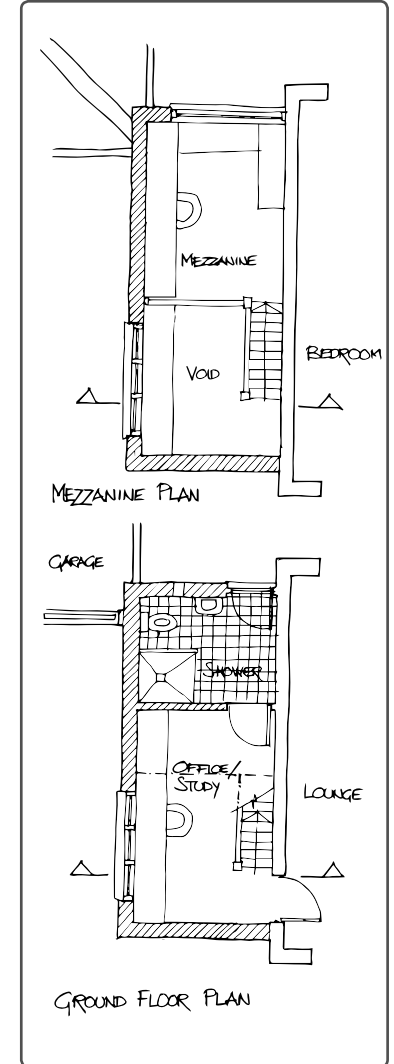

Plan of same side extension showing innovative internal use of space



This simple lean to extension fits in very well - Fenstanton



A contemporary extension has been successfully added to this older property



Extensions - amenity

When assessing the impact of an extension, there are three issues that need to be assessed. These are:-

- Loss of privacy
- Reducing the level of daylight
- Being overbearing in size and layout

Loss of privacy

Windows, balconies and roof terraces that overlook usually give rise to privacy issues and if they need planning permission, are rarely acceptable. Where the principle windows of an extension face the principal windows of a neighbouring property, there should be a minimum distance of 21 metres between principal windows of habitable rooms.

The 45 degree rule

This rule usually applies to detached and semi-detached houses.

To calculate this rule, firstly take the plan of the proposed extension, and from the midpoint of the neighbour's protected window draw a line at 45 degrees. The proposed extension should

not project beyond the 45 degree line.

Secondly, draw a line at 45 degrees to the horizontal. The proposed extension should not project beyond the 45 degree line.

If the protected window is a full height window such as a patio door, then the 45 degree line is drawn at a point 2 metres above ground level.

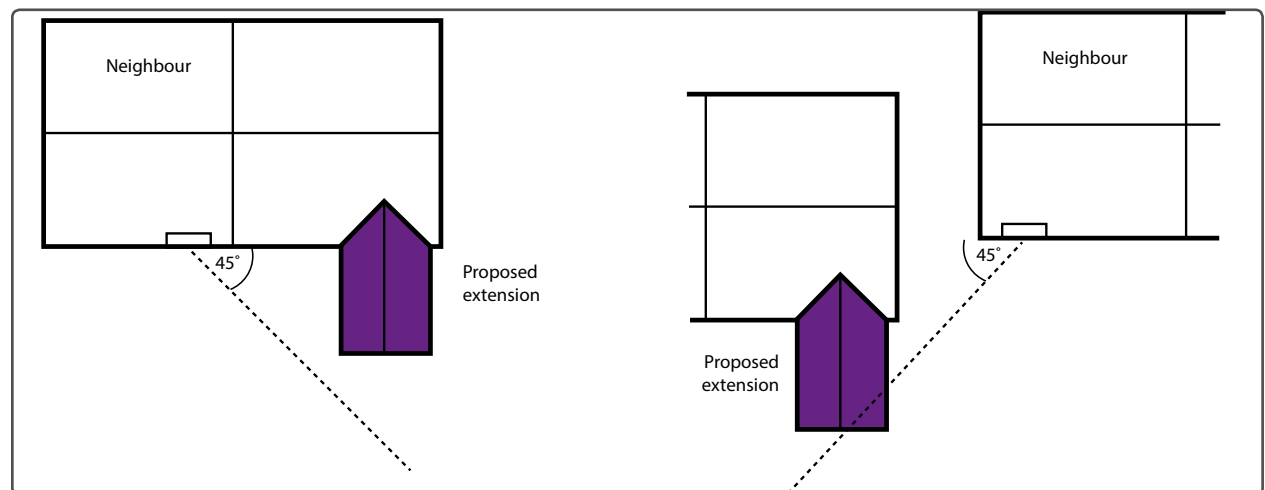

Figure 3.7.11 The 45 degree rule in practice

Reducing the level of day light

To maintain an adequate level of daylight for adjoining properties, extensions should normally obey the 45 degree and 25 degree rule.

The 25 degree test

The 25 degree test is used to check the impact of overshadowing of a proposed development to the lowest window of a habitable room opposite the development site (defined as kitchens, living rooms and bedrooms. Windows to bathrooms, toilets, storerooms, circulation areas and garages need not be assessed). First draw a line at an angle of 25 degrees from the centre point of the protected window. If the whole of the proposed development falls beneath the 25 degree line then there is unlikely to be a substantial effect on daylight and sunlight. If development is above the 25 degree line then a more detailed daylight and sunlight assessment is required in accordance with BRE digest 209 Site Layout Planning for Daylight and Sunlight (2011, Second Edition)

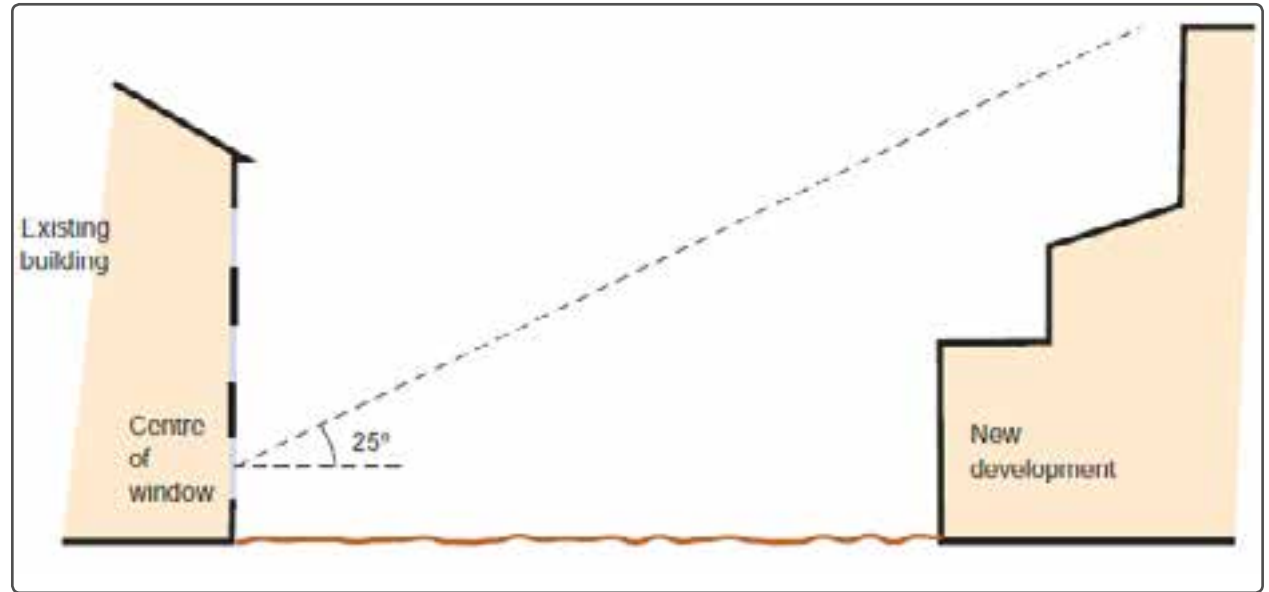

The 25 degree test used to assess the impact of overshadowing

The 45 degree test

The 45 degree test is used to check the impact of overshadowing of a proposed extension that is located perpendicular to an existing window. A significant amount of light is likely to be blocked if the centre of the neighbouring window lies within the 45 degree angle on both plan and elevation.

In assessing the impact of overshadowing of a proposed extension on the windows of an adjacent property, the following applies:-

- A, B and C are the centrepoinets of ground floor windows
- A unacceptable impact (obscured by areas 1 and 2)
- B may be unacceptable (obscured by area 1)
- C acceptable (unaffected by areas 1 and 2)
- Two storeys likely to be unacceptable

If the centre of the existing window lies within the 45 degree lines (on plan and/or elevation) then a more detailed daylight and sunlight assessment is required in accordance with BRE digest 209 Site Layout Planning for Daylight and Sunlight (2011, Second Edition)

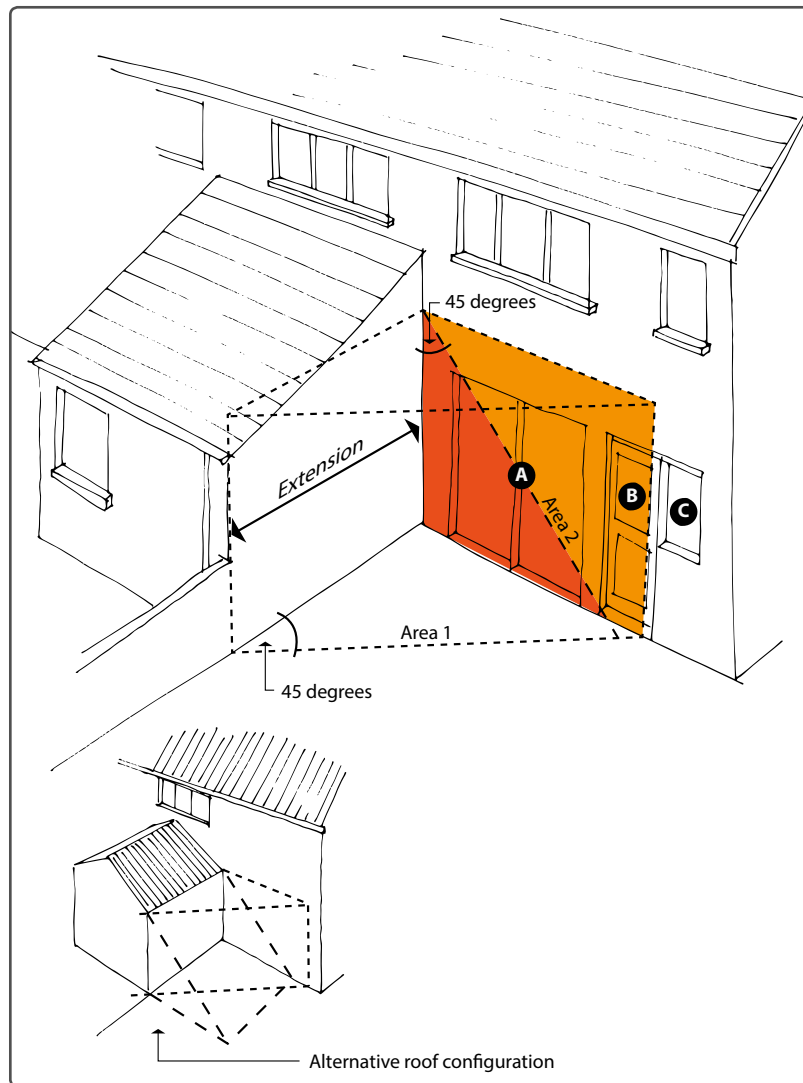

The 45 degree test used to assess the impact of overshadowing

(B)

(H)

(←)

(→)



B
H
←

The amount of glazing on this building maximise the natural light into it

Solar Orientation

Site layout should provide access to sunshine for as many buildings as possible as well as avoiding over shadowing. The following principles should be considered:

- Good natural light makes buildings more attractive to live in, work in and visit, as well as being more energy efficient. Increasing the size of windows and narrowing the span of buildings will result in more natural light in a building.
- Make the best use of the topography and existing trees on site
- Orientate buildings with the main elevation facing within 30 degrees of due south.
- Provide shelter from prevailing winds in the form of trees or landscaping.
- Address the thermal mass of a building to balance day and night heat storage.
- Minimise external wall areas, for example with the use of terraced or inter-locking built forms.
- Overheating issues in summer can be avoided though the use of shading such as deciduous trees.

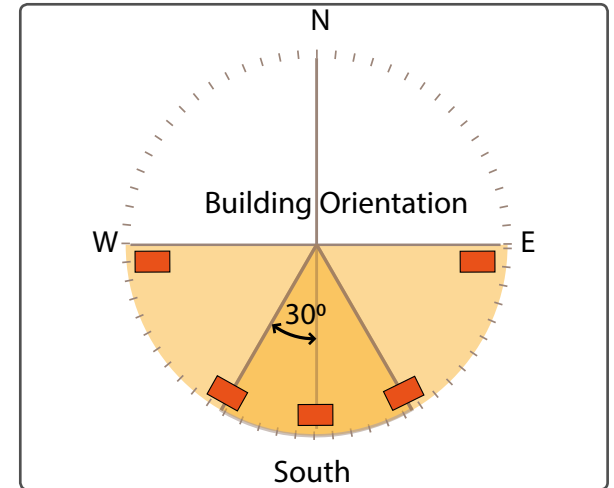
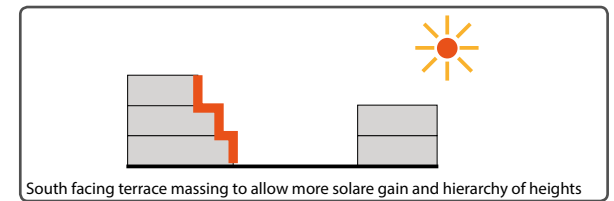

Figure 3.3.1 The optimum solar orientation of buildings



Further reading:

Sustainable Construction in Cambridgeshire - A Good Practice Guide

→

3.8 Building Detailing

Huntingdonshire has various architectural styles and materials which reflect the local vernacular, contributing to an area’s local distinctiveness.

This section identifies a local materials palette that should be drawn upon in the design of new buildings within the district.

As with building forms, there are useful design principles that can be drawn from the elevations of traditional buildings in Huntingdonshire.

These principles can be used to generate new buildings that are both good-looking and appropriate to the character of the area, and can inform contemporary design treatments as well as more traditional ones.

The Council welcomes high quality contemporary architecture that has been designed to integrate successfully into its surroundings. This may involve imaginative and unorthodox approaches to building façades, but it also demands considerable design expertise to achieve a successful result.

Further information:

The Huntingdonshire Landscape and Townscape Assessment SPD (2007) document highlights the materials and architectural styles found throughout the district.

For a brief introduction to the use of low-energy materials and sustainable construction see Sustainable Settlements (Barton, Davis & Guise, 1995)

Detailed information on materials is contained in The Green Guide to Housing Specification (Building Research Establishment, 2000).



Plain tiles



Building details and materials contribute to local distinctiveness

Brampton, Cambridgeshire

Elevation Design Considerations

There is no single design solution appropriate to every situation, nor is there any stated preference regarding architectural style, however there are some basic considerations which influence elevation design.

The main elements are window and door openings, which should respond to the type of building proposed, the composition of the street elevation and the local character.

If a designer wants to pursue a particular style rather than a contemporary design, it is essential that such a design demonstrates a full understanding of the style's intentions, its guiding proportions and correct detailing.

New buildings should be designed in harmony and proportional to each other complimenting the overall street character of the place.

Elevations can be thought of as having a top, a middle and a bottom, all of which need to be designed with care and well integrated into the overall composition.

Long continuous rooflines should be avoided so that interest and variety is created in the streetscape.

Rhythm and harmony should be an important design consideration to ensure an interesting streetscape is created. This rhythm may be vertical, horizontal or balanced.

Appropriate spacing between buildings also helps to create an interesting streetscape.

Subtle façade setbacks or material differences can help to break up monotonous façades in terraces or apartment blocks.

Larger windows are encouraged and should be located on south facing elevations to optimise solar gain.

As active a front elevation as possible should be the default position when designing a building.

1. Porch detail
2. Large ground floor windows with corner turning detail to let in more light and supervise who is at the front door
3. Large ground floor windows to let in light
4. Side windows to supervise driveway and garage
5. Garage design subservient to the main house and has extra usable space either for storage from the garage or from the house

1. Integral garage reduces ability to supervise front of house
2. Only one front window reduces amount of light entering house
3. Deep porch detail also reduces amount of light entering the hall

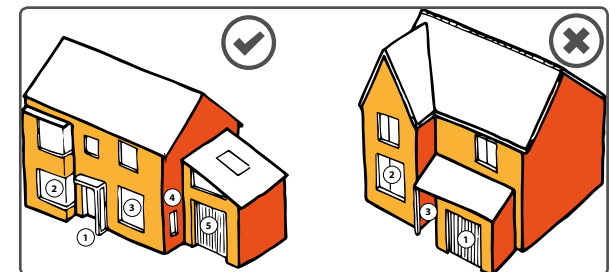

The difference between an active and a less active elevation



Poor and uninspiring elevation details



This elevation is animated with bay windows - Huntingdon

Symmetry, Articulation and Modelling

Symmetry is usually associated with classical design and is organised around the vertical centre line of the building. Symmetrical design is most appropriate in formal situations and where the elevation of a building is likely to be seen in full. Asymmetrical elevations consist of different sized elements, which appear to balance through careful consideration of their visual effect (e.g. a large window on one side of a doorway balanced by smaller windows on the other) and usually reflect the functional requirements of the different rooms in a building.

Articulation and modelling help to order a building and provide a framework for composing elevations, while also providing shade, light and visual interest.

It also describes the degree to which the parts of an elevation project or recede and this will have a considerable effect on the character of a building and its impact on the streetscape. Three broad design options involving the amount of elevation modelling can be identified:

1. flush façade - This approach is adopted when simple building forms and shapes are required, and is seen more in rural areas.
2. deep modelling - Where elements of the building project or are set back from the main line of the elevation
3. shallow modelling - This is appropriate in most situations, as it is a characteristic of most established streetscape design. The effect of highlight and shadow can enliven a façade and differentiate various elements of the building.



This plan shows a modelled house type with subservient elements

The Gable

It is important to consider views in as well as out of any new development. One important aspect is how to deal with the design of the gable. The gable has an important place making role, both as an external elevational element as well as maximising the amenity of residents by offering long distance views from the building as well as increasing the amount of light into a building.

There are many ways that gables can be 'enlivened'. The creative use of materials, the inclusion of design detail and the provision of windows all help to do this.



Successful use of materials and window to gable, Bydand Lane



Poor example - St Neots



Frontage gable adds variety, Loves Farm, St Neots



Well designed gable - Little Paxton



This gable has been enlivened in a variety of ways - Histon

B

H

←

→

Roofs, Eaves and Ridge Lines

Creating variety in the roof line is an important element of creating attractive places. When buildings run along a slope, then it is important that they step down with that slope. When there is no slope then it is also important to ensure sufficient variety in the street scene by changes in scale and roof pitch on longer runs of houses.

The following elements should be considered in the design of roofs, eaves and ridge lines:

- The overall scale of the roof should be designed in proportion to the height of the elevation and ridge heights should be limited by narrowing the plan depth rather than lowering the roof pitch.
- Subtle changes in roof pitch angle ensures a variety in rooflines avoiding monotonous building compositions
- Roofs should be kept simple in form and shallow pitches should be avoided.
- Interesting local traditions should be considered, such as mansard roofs with dormer windows, which are common in the district.

- Depending on the roofing material used, pitches from 25 to 55 degrees are generally found on traditional houses in Huntingdonshire. Steep pitches allow the loft to be utilized for accommodation and are well-suited to the use of photovoltaic panels. Contemporary flat roofs should be designed with sufficient falls for drainage.
- Architectural expression in relation to eaves treatment should be considered as part of the design process. Deep overhanging open eaves can often add interest to any building. Cottage eaves and open rafter feet can add pleasing detail to a building. Boxed in eaves can often look overbearing, particularly if they are painted white.
- The traditional use of ‘tumbled’ brickwork (see page 156) detail for weatherproofing and as a decorative verge is encouraged in sensitive locations.

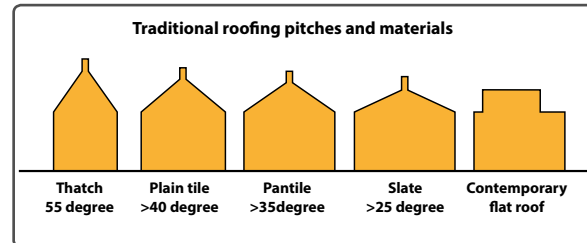

Fig 3.8.2 Roof pitches



Ramsey, Cambridgeshire



Brampton



Warboys



Huntingdon



Huntingdon

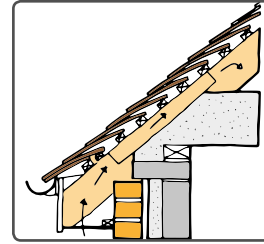

1. Eaves with soffit ventilation

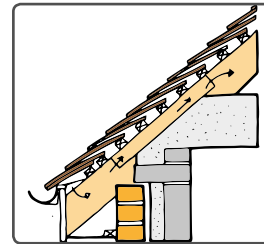

2. Eaves with over fascia ventilation

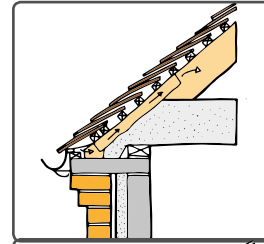

3. Cottage eaves

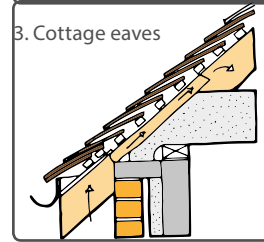

4. Open rafter feet



St Neots, Cambridgeshire

Chimneys

Chimneys add interest to roof lines, even if they are no longer needed to heat the home.

Chimneys feature in traditional buildings and can be reinterpreted for modern buildings. For example: the Accordia scheme in Cambridge includes a modern interpretation of the traditional chimney.

Chimneys would normally be placed symmetrically on the ridge, either centrally or built up from the gables.

The use and location of GRP chimneys must be carefully considered in conjunction with high quality flashing details

The traditional use of 'tumbled' brickwork (see p155) detail for weatherproofing and as a decorative verge is encouraged in sensitive locations.



Roof line interest added through the use of chimneys



The repetitive nature of this chimney design contributes to the success of this design



The repetitive nature of this chimney design contributes to the success of this design



Chimneys add a welcome interest to roof lines

Fun with Details and Materials

High quality buildings can incorporate design features such as unusual materials, patterns within the brickwork / materials or different shaped windows. This can add interest and act as positive landmarks which aid legibility and make it easier for people to orientate themselves and recognise where they are. Appropriate “conditions” for such design features include buildings which occupy key nodal points, gateways, the ends of important vistas and groups of buildings surrounding junctions and public open space.



Godmanchester



Fenstanton



Godmanchester



Fenstanton



Loves Farm, St Neots

B

H

←

→

Brickwork

Huntingdonshire has a wide range of traditional brick materials as a result of the underlying Oxford and Gault clays, and the lack of good building stone over much of the district. Cream bricks are found most commonly in the district, but red bricks are also found, albeit less frequently.

It is crucial that new brick work matches the colour palette of its locality.

Brick detailing in the district is generally very simple, even on grander buildings. Features such as lintels, string and dentil courses are usually the same colour as the main facade, although there are examples of contrasting brick colour.

Brick plinths, often painted black, are a traditional building feature as well.

In sensitive or prominent locations, it may be appropriate for new buildings to use Flemish bond or English bond for any brickwork. Garden wall bonds should be used for boundary walls. Light coloured mortars should be used in both instances.

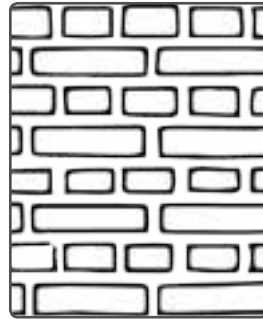

English bond

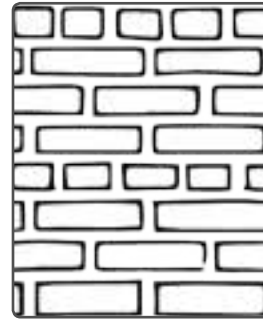

English garden wall bond

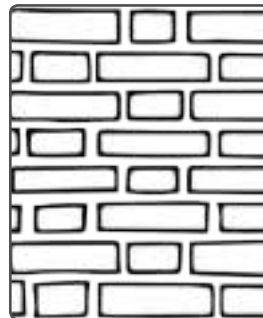

Flemish bond

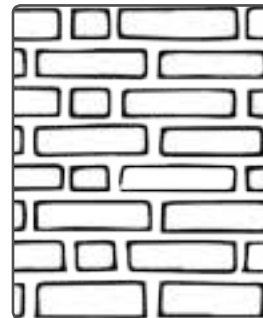

Flemish garden wall bond

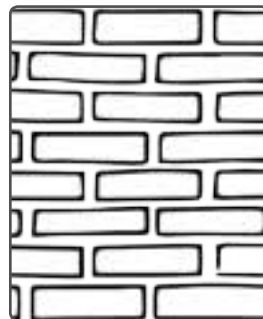

Stretcher bond

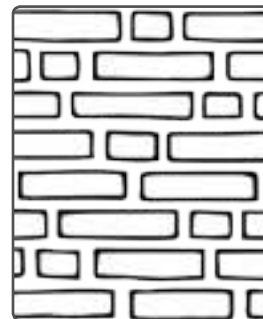

Monk bond



Tumbled brickwork



Brick detail



Detail of brick arches

Enrichment

Our towns and villages can be enriched by the use of subtle detailing on the occasional building, in the past this was often at the whim of the builder, architect or developer, and this art seems to have died out. Some of the examples shown here include the use of brick corbelling on the corner of the building, gargoyles, and stained glass windows. There are many ways of providing such interest, but the important thing is not to forget about this useful way of enhancing a development.



Corbel detail



Direction sign attached to building



Gargoyles can provide enjoyment - Huntingdon



Huntingdon, Cambridgeshire

Pipework and Utility Boxes

The location and design of services on a building must be considered carefully. A proliferation of poorly-positioned pipes, boxes and other additions is unsightly, and every effort should be made to locate these items as unobtrusively as possible.

Pipework should be grouped together and run internally wherever practical. Chimneys can be used to disguise gas flues where they do not serve a working fireplace. Rainwater goods should be dark coloured (preferably black), and of half-round profile for gutters (with round downpipes).

Meter boxes should be designed into a scheme from the outset to avoid cluttering the elevations. They should be on end rather than front elevations where possible and be in a colour that blends in with the surrounding wall. The introduction of smart meters may mean that external boxes are unnecessary.



Carefully disguised pipework - Huntingdon



Poorly located meter boxes - St Ives



More discreet meter boxes examples



Huntingdon, Cambridgeshire



Services

Shared common trenches should be designed for service and drainage runs to minimise disturbance to the site around buildings and sited under the verges and service strips. Where pavements are excavated these should be reinstated with matching materials.

Any damage to the root system to retained trees must be avoided. Service runs should not be located within the tree root spreads or reserved new tree planting corridors.

It is important that similar or appropriate material as the surrounding paved areas are used for manhole covers and that they are designed to be unobtrusive and with ease of maintenance in mind.

Substations and other service kiosks should be fully integrated into designs.

These are such simple details to get right which detract from the overall design if not considered from the outset.



Un-coordinated services - Huntingdon



Discreet drain cover within paving, Walden Walk, Huntingdon





How not to locate or design a substation



Semi concealed gas meter



Substation clad in contemporary design



Attention to detail



Screen to hide kiosk



Cabinet hidden behind a reveal in the wall



Well ventilated bin store



Substation design reflecting adjacent building

Doors

Doors form the focal point of an elevation, and need to give a feeling of solidity. Those on traditional buildings tend to be of vertically-boarded timber construction and of panelled design on more formal and town houses. Traditional doors have six or four panels.

Glazing in doors should be limited in order to maintain their 'solid' appearance, and patterned effects should be avoided; they tend to appear over-fussy. Fanlights can be positioned above doors. They should not be integral to the door itself.

Door surrounds are a common feature of formal houses built in this area during the 18th and 19th centuries, and were sometimes added to traditional cottages. They can be an attractive addition to new properties, adding emphasis to the principal entrance, but should be of an appropriate simple style.

Doors with deep recesses are also a feature of 19th century housing. This design detail is now a useful device for 21st century homes for hiding service details as well as providing interest and relief to the front elevation.

The effect on the street scene must also be considered; they are unlikely to be appropriate in a row of houses or a terrace which is otherwise porch-free.

The design of doors in new development should take into account the context within which the development sits and the architectural character of the proposal.



Door set back in reveal - St Ives



St Ives, Cambridgeshire

Entrances to Flats and Offices

Entrances to flats and offices should be open and let in light and be located in an obvious position. Stairwells within a building should be flooded with natural light.

All designs should ensure compliance with the relevant Building Regulations access requirements.



The entrance to this building is light and airy



Pleasing shared entrance design to flats



This apartment block has been cleverly disguised as a pair of houses, and the entrance has been designed appropriately



Main entrance to office building

B

H

←

→

Porches and canopies

Porches are often the key focal point of a building and should be designed with commensurate care. A well-designed porch or canopy can enhance and give interest to a new building as well as reinforcing local building traditions. Conversely an ill-conceived porch can blight even a well-designed new building and add an inappropriate and discordant feature.

Traditional Forms of Porch

Those porches that were part of the original design of a house, or those that were added later, were generally very simple open-gabled or lean-to roofs supported either on posts or brackets fixed to the wall of the building. A recessed draught lobby located within the house is often more appropriate than a projecting porch or canopy.

Porches on New Buildings

Generally on new buildings, porches should be kept small and simple and relate to the style of the building to which they are attached. An open canopy is often the most appropriate form. Traditional style porticos should be avoided. Modern enclosed porches are

welcomed if they are an integral part of the overall design of the house. Glass canopies should be avoided.

Porch roofs need to be visually separated from the main roof of the dwelling in order to produce an authentic feature. Porches can provide storage for bulky items such as bins and cycles if designed carefully as part of the structure and overall design composition.



Storage cupboard, Loves Farm, St Neots



Contemporary canopy



Extra wide Canopy with discrete bin stores



Traditional canopy, Brampton

B

H

←

→

Windows - Residential

Windows are the ‘eyes’ of a building and are crucial to its character. In general, they should have a vertical emphasis. This can act as a visual ‘counterbalance’ to the horizontal proportions of wide-fronted properties, and helps to maintain privacy from the street.

Unless they form a fundamental aspect of the design concept, large un-subdivided panes and asymmetrical windows should be avoided, as they detract from an elevation’s proportions or its sense of solidity.

A limited range of traditional window patterns are characteristic of traditional houses in the district, and provide appropriate models where a period effect is sought or required.

Where possible, timber windows should be selected over uPVC alternatives; they can allow a finer profile to be achieved (giving visual benefits), tend to be more durable (if properly maintained) and their embodied energy is less.

B

Aluminium windows can also offer a much greater range of design possibilities than uPVC alternatives.

H

It is important that for good internal lighting the default position is for large windows on new development.

←



In general, traditionally styled windows look best when painted white; although other colours are welcomed as they add interest to the street scene. Grey windows are becoming more popular in contemporary developments and are an acceptable alternative, adding variety. Windows inserted into black weather-boarded buildings are best painted black to match.

Cills and lintels frame a window and should be designed with care. Timber lintels are the simplest form, characteristic of vernacular construction in timber-frame, stone or brick areas.

In brick buildings, segmental ('curved') and splayed lintels are more attractive than standard soldier course details, as well as being characteristic of traditional buildings in the area. Brick lintels are usually the same colour as the rest of the building.

Stone cills are more common than brick cills and are normally thicker than one single brick course. Stone cills are usually for the front of the house or to the side if it faces the street.

Where buildings are rendered, the lintel is usually concealed beneath, with a simple drip mould to throw off rain water. On formal

houses, the assumed line of a brick lintel was sometimes scribed into the render.

Principle ground floor windows should generally be larger and deeper than first floor windows, helping to create an attractive street scene.

Bay and box windows are welcome and should be used often in new housing developments, they add interest and a degree of modelling to the main elevations.

Attractive contemporary window designs and compositions are welcomed, they usually consist of larger expanses of glass which helps to bring more light into the home and workplace.

Corner windows are encouraged, they add delight and architectural interest.

Windows should be set in from the outer wall. This is known as a reveal. A reveal of 75mm will provide a suitable depth to provide shadow and interest to an external elevation.



Godmanchester, Cambridgeshire





The interplay between windows set in a reveal and boxed windows is appealing here



A simple bricked in dummy window with a reveal can add relief to a wall - Huntingdon



Perfect window proportions - Huntingdon

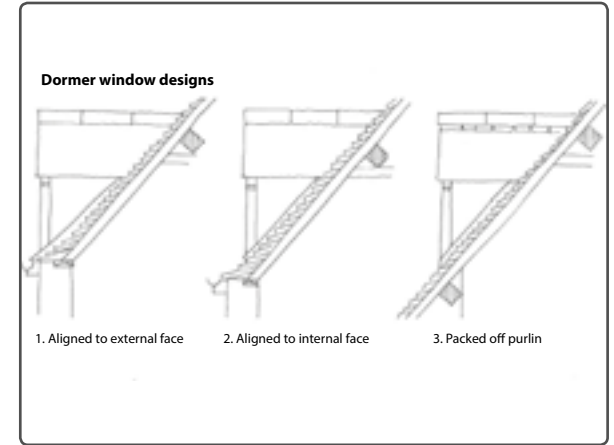

Dormer window designs



These dormer windows sit lightly on the roof of this cottage - Holywell



This repetitive window pattern of bay windows adds character to the street - Huntingdon



This side window adds interest



Oriel window



This corten steel window has a deep projection that adds interest to the building



Corner window adds interest



The size and the colour of the bay window creates additional interest



Large ground floor windows enliven this house



A small corner window - Ramsey



This corner window supervises the driveway



Windows must provide balance, and should enliven the elevation

Cambridge



Windows - Commercial

In office and other commercial buildings, similar principles of balance apply. The appropriate amount of solid and void will generally relate to the function of the building, but where windows are proposed they must be attractively proportioned and enliven the elevation of a building. A deep reveal also adds pleasing elements of shadow and light to a building.



Deep reveal on this office building



Interesting use of materials



Unique window design



Balconies

Balconies are an important elevational detail that can detract from the overall streetscene if they are incorrectly designed, and some can look like they have been 'stuck on'. Externally applied framework balconies should therefore be avoided.

Balconies must be an integral part of the building, and have to act as a means of importing light while not cutting off light for residents below. Where possible balconies should be a generous and be a minimum of 1.5m deep in order to accommodate a table and chairs.



Generously proportioned external balcony



Deep external balconies



Top floor external balcony



Poor external balcony design



Substantial internal balconies

Hard Surfacing Materials and Laying Patterns

Paved areas are a major element within most developments, and their design has a significant impact on the overall appearance, quality and success of a scheme. Care must be taken when choosing the materials and when detailing paved areas as part of the overall design. Surface water management should also be considered when designing paved areas.

High quality materials such as stone, gravel and brick can provide a durable and attractive hard surface, although there are an extensive range of modern materials that can contribute positively to the quality of outdoor spaces if chosen with care.

The highest specification of materials, such as natural limestone or sandstone, will usually be expected in areas of special significance, such as civic spaces and adjacent to listed buildings. The laying pattern and materials used can make a significant contribution to the overall appearance, quality and success of a scheme. 45 degree herringbone patterns are less visually pleasing than other laying patterns such as random bond, broken bond, gauged width, and the European fan.

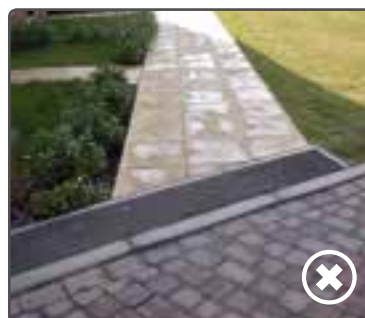

Uncoordinated surfacing of materials



Bedford, Bedfordshire

Large unbroken areas of a particular surface material should be avoided, especially tarmac, and areas can be broken up successfully using materials of a similar colour but with different textures.

It is also important that where there are large development projects with more than one developer, these different developers adopt the same consistent palette of materials and designs.

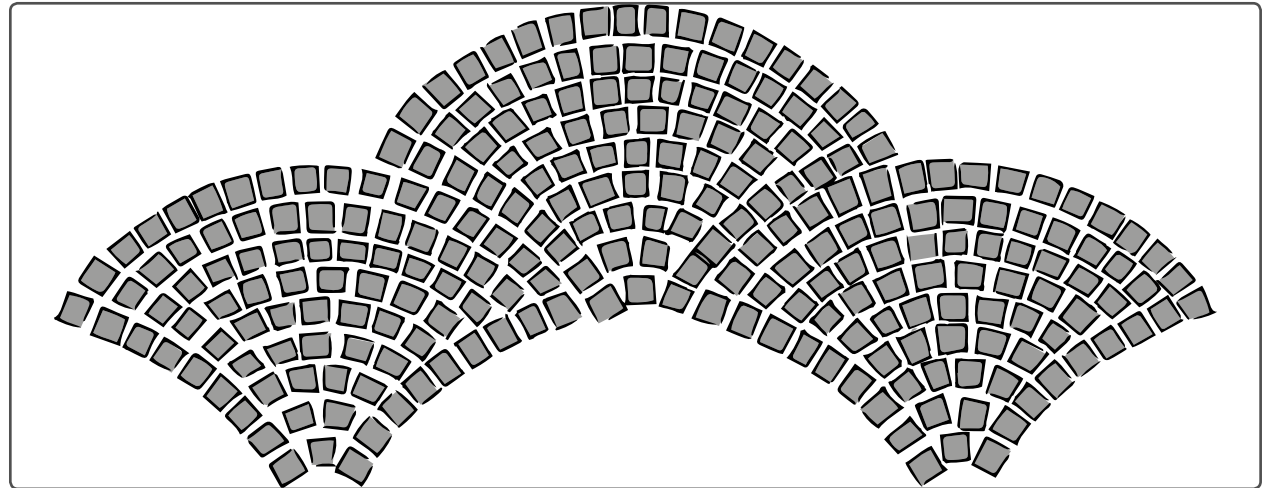
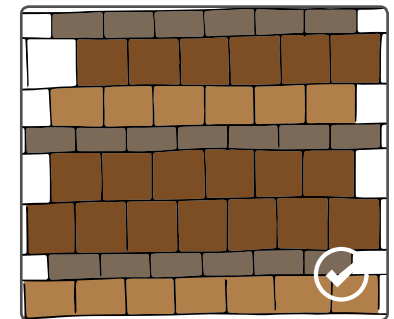
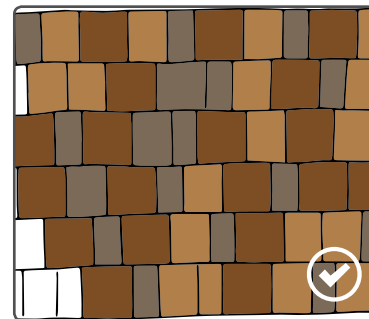
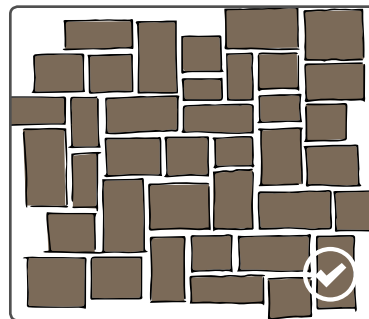

Figure 3.8.3 European fan laying pattern



B

H

←

High quality hard surface materials - Huntingdon

→

Boundary Treatment

Boundary treatments provide the interface between private ownership and public property. The treatment of these boundaries is fundamental to the creation of a safe and secure environment for residents and helps to create a unified and uncluttered streetscape.

In all instances, boundary treatments must be constructed of robust materials that are consistent with their context.

Boundary treatment options include: stone or brick walls, wooden or metal railings to a maximum height of 0.9m along the front of properties. Side or rear boundary walls should be a minimum of 1.8m and a maximum of 2.1m relative to the width and depth of the garden. If the side or rear walls are in the public realm then these should be either solid wall or high hedge, or a combination of both. In certain circumstances where floor levels have been raised due to flood risk, boundary treatments may need to be increased in height to maintain privacy.

(B)

The privacy strip can be planted with soft landscape and can include low shrubs, individual specimen trees and climbing plants.

(H)

(←)

Large expanses of high solid wall should be avoided.

Shared surfaces in mews developments will be the least formally treated in terms of boundary definition, with a single shared surface level from building front to building front. Privacy strips of 0.5m should be incorporated immediately adjacent to properties.

The rear or side boundary of homes which share a secure central courtyard must allow surveillance of courtyards from habitable rooms whilst maintaining privacy within the rear garden area.

Palisade fencing should generally be avoided. It is unsightly and does not contribute to the creation of attractive places. Where security concerns are paramount, better alternatives such as Weldmesh together with appropriate planting species should be considered.

Site boundaries should be constructed from materials that will allow water to flow in flood risk areas.



Attractive low wall - Colne



This wall is well detailed and finished - Brampton

(→)

The following principles should be followed:-

1. Brick wall can dominate if used too much. Use soft landscaping and hedgerow planting as much as possible to soften the impact of brick walls, or use as a replacement.
2. To finish off the wall use a well-designed coping. A soldier course header will not generally be acceptable.
3. In sensitive or prominent locations, an English garden wall bond will be expected.
4. Where a brick wall changes direction, ensure that a saw tooth connection is not shown and use squint and angle bricks instead.
5. Estate rails, hedges, post and rail and knee rails are all boundary treatments that if used well and detailed well, can contribute to the creation of an attractive place. Knee rails with a morticed join are preferred to the 'v' notched diamond version.
6. Close boarded fencing should be avoided in locations facing the public realm this includes communal and semi-public parking areas such as rear car courts.



Well detailed brick wall



Estate rail fencing



Morticed knee rail fence



This post and rail fence works well in this urban environment



Robust hedge forms an attractive boundary

Building Thresholds

The design of the building threshold has an important role on the overall appearance of the building. It is crucial that the building finished floor level and associated access has a sympathetic relationship with the surrounding ground levels. In some situations the finished floor level may need to be raised to take account of flood risk constraints.

When considering finished floor levels, access requirements to the building (ideally from the front) and associated level access must be considered in relation to adjacent ground levels. Access to new development does not need to involve the use of over engineered solutions in most situations. Subtle use of level changes can create the necessary access to the door threshold.



Stepped terrace responding to slope and creating level thresholds to each dwelling



Problems with getting the building threshold sorted out at the end have resulted in a poor solution here



This example shows a building threshold that has not been thought about until the end



Level threshold



The building threshold is well detailed and unobtrusive

B

H

←

→

Materials

Materials and their detailing can have a significant influence on people’s perceptions of the quality of a place. Materials should complement the successful parts of any surrounding development, in order to conserve or enhance the distinctive character of the various parts of Huntingdonshire, and also to ensure that buildings sit comfortably within the landscape. Materials should be avoided that ‘borrow’ heavily from the vernacular of other areas as they will erode local character.

Generally, quality can most easily be achieved through simple forms, with limited decoration and with well-proportioned elevations and high quality materials and detailing. A limited palette of materials will usually achieve a more cohesive result.

Changes in material should relate to the form and articulation of the building, for instance to a set back or projection, or should have some other clearly identifiable role in the design. Where materials and details are used to reflect traditional building forms or vernacular architecture, then they should be a genuine reflection of those traditions rather than ‘stick-on’ features.



Uncompromisingly modern materials such as exposed steel, fair faced concrete and structural glazing can be employed to good effect, but need to be detailed to a high standard if they are to look good and retain their visual appeal.

In larger, neighbourhood scale developments, there will be a need to balance the degree of variety and consistency in the design of buildings, to create areas with their own distinct character and key marker buildings. Changes in the use of materials can play a role in varying character, although this should not be the only means of creating variety.

As far as possible, the materials should also promote sustainable forms of construction, favouring low embodied energy.

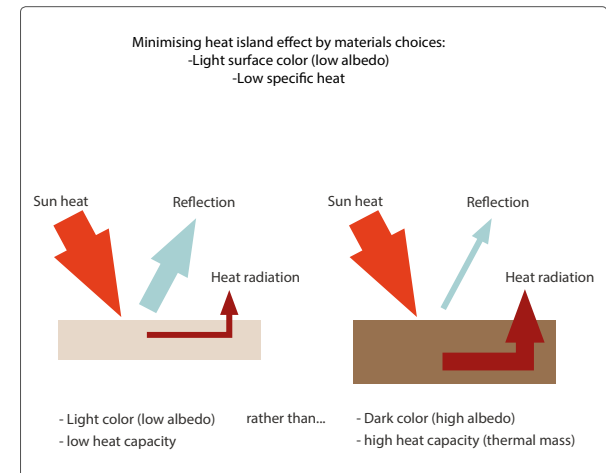
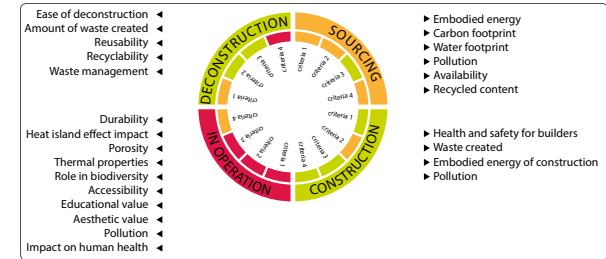

Weatherboarding

This is a widely-used cladding material in the rural areas, associated with barns and outbuildings.

Weatherboarding in Huntingdonshire was usually pitched to a dark colour. It is now being used more often as a natural colour and left to weather naturally. Coloured boarding can be successfully used in more modern development to provide interest. This can be a maintenance free pre-coloured material such as a fibre cement boarding which has the appearance of stained wood.



St Neots, Cambridgeshire

Which timber?

There are various options available for timber cladding:

Western red cedar is among the most popular softwoods used today. It has a natural resistance to decay and moisture absorption, meaning it can typically be installed without treatment. It's also the most stable of the softwoods, subject to little movement once installed, and its low resin content means it can be readily stained or painted. However, it is susceptible to being dented if knocked.

Douglas Fir is another popular choice. UK grown Douglas fir may require a protective coating to improve durability.

Scottish and Scandinavian larch is denser than western red cedar, making it more resilient to knocks.

Green oak will naturally weather with age to a silver-grey colour and has the advantage that no further maintenance will usually be required for anywhere between 25 to 100 years. Sweet chestnut is another hardwood choice. Both oak and sweet chestnut contain high tannin levels which can leach out resulting in dark streaks.

Such marks do however disappear after a couple of years of weathering.

There are also an emerging group of thermally modified timbers such as ThermoWood, Accoya, Thor, Kebony, Keywood and PlatoWood. These are created by a process that typically involves heating less durable softwoods such as pine in order to remove moisture and resin. The timber may also be injected with chemicals. The result is a very durable and stable product.

Shingles and Shakes

Shingles and shakes are made from split logs and have an appearance more like timber tiles than boards. Shingles tend to look neater and more precise than shakes, which give a more rustic appearance. As a cladding material they work well on both contemporary and traditional homes. Shakes are usually made from Western red cedar, giving them good durability, and can also be supplied pressure treated with preservative for enhanced protection.

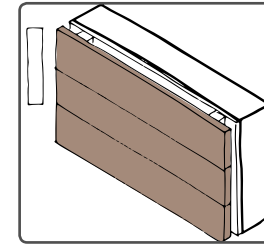

SQUARE EDGE - This type of boarding boards has a uniform thickness usually between 12-18mm.

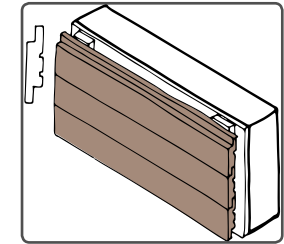

SHIPLAP - Shiplap has a shaped front face and profile so that the top of each board fits behind the other and is very neat

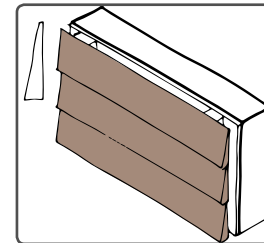

FEATHER EDGE - Boards are tapered across their width. This style of board produces a rustic, rural appearance that is perfect for more traditional homes, or barn style self builds

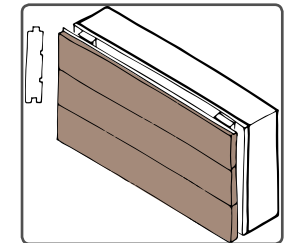

TONGUE & GROOVE - These produce a uniform look that suits contemporary houses. They have a flat face and in the absence of any overlapping, rain is kept out by the way the groove covers the tongue of the board below

Render

Render is a traditional finish within the district, used to protect the walling material beneath. Traditionally, render is a smooth floated finish in a limited range of naturally-occurring colours (these are examples of other colours as well).

Render mixes with a lime/sand content applied with a wood float are recommended to create a finely-textured finish. Grey coloured cement mixes or highly-textured finishes, such as Tyrolean or pebbledash renders, look out of place and should be avoided.

It is still possible to derive pleasure from the careful choice and application of colour to a house.

The use of though coloured render is encouraged as it doesn't require external painting and limits the need for future maintenance.



Catworth



Somersham



Kimbolton



Good use of render

Stone

The north western part of the district is characterised by the mellow grey limestone of the Nene Valley. Elsewhere in the district there is evidence of dark, iron-rich ‘carstone’ and small brown cobbles, although building work in these irregular materials is limited to areas where the material was readily available.

Traditional cottages in the Nene Valley are generally constructed in random rubble, while larger grander houses may be built in ashlar, creating a refined crisp appearance.

When building in stone, pay close attention to its colour, the coursing, block size and the mortar to be used. Mortar joints should be kept tight with a slightly recessed, brushed finish.



Wansford



Elton



Elton, Cambridge

Brick

Huntingdonshire has a marvellous range of bricks as a result of the underlying Oxford and Gault clays, and the lack of good building stone over much of the district. Colours depend on the chemical content of the clay and the firing conditions; dark rosy red, grey-buff, cream with hints of green, and pale, almost white, bricks are found in different parts of the district.

It is crucial that new brickwork matches the colour palette of its locality, bearing in mind that it may change from village to village.

When selecting bricks, shiny engineering bricks, bricks with an applied or a heavily textured wire-cut finish, and bricks with poor colour quality are generally of poor visual quality and should be avoided.

Brickwork detailing in the district is generally very simple, even on grander buildings. Features such as lintels, string and dentil courses are usually the same colour as the main façade although there are occasions where the designer has used contrasting bricks to good

effect. Often the plinth consists of black painted bricks, or more modern interpretations use blue engineering bricks.



Great Gransden



St Neots



Sawtry

B

H

←

→

Commercial Use of Brick

There are some recent examples of large commercial buildings that have used brick for the main construction material resulting in large expanses of almost unbroken brickwork. These buildings can overwhelm a street and do little to positively contribute to the feel of the overall townscape.

Other larger format materials would be more suitable for such buildings.



Even the red brick banding does not help here - Huntingdon



Vast expanse of brick creates a poor environment - Huntingdon

Cladding systems

Cladding systems are another alternative material and can be effective, particularly in town centre and commercial schemes. They add colour and interest to elevations and are particularly effective over larger areas.



New and old contrast



Colour banding helps to blend the building into the landscape



Clean and crisp lines



Contemporary detailing with a traditional twist



Fun with cladding materials



Cambridge

Roofing Materials

Roofing materials in Huntingdonshire are as varied as the walls. They have an equivalent impact on the character of a scheme, and so appropriate selection of roof coverings is vital.

Thatch

Widely used in medieval times, the steeply-pitched (50° or over) thatched roof remains an important characteristic of the district. Formerly, the majority of the district followed the long straw thatching tradition while water reed was more readily available in the Fen and Fen Margin. Latterly, due to its increased longevity and a reduction in the availability of suitable straw, reed thatch has replaced many straw roofs.

New thatched buildings are encouraged along with appropriate detailing, but it is important that the long straw tradition continues in those parts of the district where it is most at risk, due to its contribution to the distinctive character of those areas.



Great Gransden



Brampton

Collyweston Stone Slates

Collyweston stone slates are a rare and finite resource, largely used for roofing from the 16th to the 18th centuries. They characterise the north-west of the district, used in conjunction with limestone buildings and at a pitch in excess of 50°.

Where existing collyweston slate roofs exist they should be retained rather than 'quarried' for salvage or replacement. As the material is so scarce and sources are retained for use on historic buildings, new developments in suitable locations may be permitted to use appropriate man-made alternatives.

"Limestone can yield a roof covering of incomparable dignity and beauty. When the building is itself constructed of local limestone, a roof of stone slates adds the crowning touch of harmony, in colour and in texture, with the surrounding landscape."

Sir Alec Clifton-Taylor

The Pattern of English Building

1962



Wansford

Pantiles

Clay pantiles have been commonly used in local building since the end of the 18th century, predominantly on modest single storey dwellings or outbuildings. They are rarely found on higher status buildings. A pitch of between 35° and 45° is normal, but steeper pantiled roofs can be found where they have replaced thatch.

The profile of pantiles varies, from single roll (so-called 'Roman' pantiles) to corrugated types. Colouring reflects the red, buff and pink of the Cambridge Mix peg tiles, although dark red tiles imported from outside the district are also found.

Pantiles remain appropriate on outbuildings or garages and can be obtained in colours and profiles to match the local palette. Bright orange or red pantiles are not usually appropriate, as they tend to look too vivid.

Heavy, large concrete alternatives will not normally be acceptable, as they do not offer a subtle enough profile.



Fenstanton



Holywell



Hilton, Cambridgeshire

Pantiles have been commonly used in local building from the end of the 18th century

Plain Tiles

Plain clay tiles, known as ‘peg’ tiles in their early form, are widely used across the district. Peg tiles characterise buildings of the 18th or 19th centuries, although they are often found on older buildings as replacements for thatch. Normally they are laid at pitches of between 40 and 50°. Their colouring reflects the local clay types, ranging from a predominant red/brown in the south-west of the district to the ‘Cambridge Mix’ which includes whiter and pinkier hues. As a small unit, hand-made tile, they provide a rich varied texture to a roof surface which is rarely reproduced by machine-made alternatives.

Plain tiles, whether clay or concrete, will be a common choice in new development and it is important that tile selections are made with a view to their visual impact, particularly their colour and size. Very often, a tile of one well-considered colour will be most successful in maintaining the simplicity of a street scene, rather than seeking to mimic aged effects. Small unit double cambered tiles offer a more subtle texture on a roof than chunky, interlocking alternatives.



Holywell



Brampton

Plain clay tiles, known as ‘peg’ tiles, are widely used across the district



St Ives, Cambridgeshire

Slate

Natural slate became the foremost roofing material in the 19th century, usually sourced from Welsh quarries. Laid at pitches as low as 25°, slate was often used in conjunction with the deeper plans of urban terraces.

Slate will be an appropriate choice for roofing where the context suggests it is a common material. For example, terraces and other urban building types are more suited to slate roofs than cottages in a rural setting.

Colour, size and texture are important considerations. Imported natural materials should match the bluish grey colouring of Welsh slate where possible. Thick, slate coloured concrete interlocking tiles are not suitable alternatives to natural slate and some fibre cement ‘slates’ can look flimsy and have reflective un-weathered appearance. Reconstituted slates that closely resemble natural slate in composition and appearance may form an appropriate alternative to imported natural slate.



Slate roofing on a contemporary development at Loves Farm, St Neots



Slate roof at Temple Close, Huntingdon



Natural slate became the foremost roofing material in the 19th century

St Ives, Cambridgeshire

Standing Seam Detail

Sheet steel has a long tradition as a roofing material, and metal standing seam roof materials are often used on contemporary residential and commercial buildings. Zinc and copper are the most used metals. Cheaper applied materials, that seek to replicate the effect of metal standing seam details can be unconvincing and are not recommended.



This material is a poor substitute for real metal standing seam



A good example of standing seam used on this ventilation chimney, Cambridge



Here we can see this applied material bubbling up



This section sets out a step by step process and development scenarios that show how the previous sections can be brought together



4.1 Implementation

This chapter draws on the guidance set out in chapters 1 to 3. It sets out a step by step design process that should guide the development of all planning proposals. It also includes a series of development scenarios that show how the guidance in the previous chapters can be brought together.

All development proposals should seek to ensure that the following design principles have been achieved within new development in the district:

1. Locally distinctive

New development should form a cohesive part of the existing environment, whether this is urban or rural, respecting its local context.

2. Continuity and enclosure

In high density areas the design should ensure a continuous street frontage and provide enclosed spaces with clear definition of public and private areas.

3. High quality public realm

Streets and public spaces should be built with a palette of high quality materials and

specification that have been agreed with the Council.

4. Puts people before traffic

New areas should be well connected to the surrounding area by a range of transport choices. People should be able to walk and cycle safely within a comfortable living environment.

5. Legible

Routes through new development should be legible with landmark and accent buildings and spaces created at key locations to assist in the overall sense of place and orientation.

6. Adaptable

Development should be designed to accommodate future expansion, changing land use requirements and future technological, environmental and economic conditions.

7. Diverse

Residential areas should provide a range of densities and also include complimentary land uses that support the needs of the community.



Primrose Lane, Huntingdon

- 4.1
- 4.2
- 4.3
- 4.4
- 4.5
- 4.6
- 4.7
- 4.8





4.2 The Pre-application Design Process

The approach taken to implementing any particular development can be regarded as a step by step process, based on the evolution of the scheme and an understanding of the particular part of Huntingdonshire in which it is located.

The route to the Planning Application Stage will usually consist of the following steps:

Step 1

Opportunities and constraints

Select an appropriate site for development based on the site constraints, potential technical issues and what policy is likely to allow.

Understand the character of Huntingdonshire

Identify the character area, growth area or market town in which the proposed development is located. Consider the key characteristics and design principles as the starting point for the design process.

Understand place-making and design principles

Recognise how the Place-Making and Design principles set out in the guidance will be used to assess the design quality of development proposals.

Step 2

Analyse and Appraise the site and its setting

Carry out a detailed appraisal of the site and its more immediate setting. Consider how the proposals relate to the adjacent built and natural environment, as well as how the proposals have taken account of the features and constraints of the site and its setting.

Step 3

Develop the design concept

Determine an appropriate development concept that responds to the relevant part of Huntingdonshire and to the Place Making principles set out in section 3.

Step 4

Develop the proposal

Undertake an iterative design process, looking at things like density, land use, access and movement.

Step 5

Making the application

Ensure that sufficient drawings and supporting documents have been prepared to support the application.





ONE

INITIATE

Step 1: Opportunities & Constraints

The project should be initiated with a detailed site appraisal to understand the site opportunities and constraints. This will need to include any site surveys required to support the application process, particularly if an Environmental Impact Assessment (EIA) is needed.

The following information should be understood from the outset of the project:

- The likely extent, purpose and objectives of the proposed development
- All planning policies applicable to the site and the development proposed.
- Any constraints or restrictions to development that would affect whether or how the site could be developed, such as flood risk, as well as any local designations such as conservation areas or tree preservation orders.
- The planning history of the site to identify any previous developments or planning decisions which may restrict development on the site
- Legal issues including restrictive covenants,

conditions attached to a lease, or easements, site ownership issues, Public Rights of Way protections etc

Depending upon the scale or sensitivity of the site, it may be appropriate to produce a development brief or master plan for the scheme. This should encompass details such as the extent of the site, the purpose and objective of the development, type, scale, functions and size of proposed development, environmental standards to be achieved, and timescale for the project. This process may be initiated by the Council.

A design team should be assembled at the outset to prepare and formulate the planning application. This should include architect, landscape architect, urban designer, transport planner, and sustainability consultant roles.

An initial pre-application discussion with the council should take place at this stage to review initial context and ensure planning policy and procedural requirements are being met.

Consultation with organisations such as the Environment Agency, Cambridgeshire County Council or the Middle Level Commissioners are likely to be useful at this stage to help understand constraints and opportunities.





TWO

ANALYSE & APPRAISE

Step 2: Analyse and Appraise

The second stage should comprise a detailed analysis of the site context. The Council will seek to ensure that a clear understanding of site context, constraints and opportunities has been demonstrated. This will form part of the supporting information to be submitted with the planning application. This should demonstrate:

- How the site relates to the surrounding scale and pattern of development, local building styles, materials and details
- Physical site constraints including access points, Right of Way, site levels, topography, watercourses, flood risk, soil quality, solar orientation, wind directions, ecology, archaeological constraints and utility constraints
- Environmental constraints including designated sites, such as Sites of Special Scientific Interest (SSSI), biodiversity value, landscape character, structural landscape and tree belts, Tree Preservation Orders, hedgerows, or distinct field patterns.
- Output from the various site studies and supporting evidence which consider the

principal constraints and opportunities should be referenced in the emerging development brief or urban design framework and shown in graphical form where possible as represented in the example overleaf.

- Relationship with surrounding uses, including privacy and access, density, height, key view corridors, Green Infrastructure Network, landmarks or other important features.



Site Appraisal

A key output from the various site studies should be a site appraisal drawing (or drawings), which pulls together the principal constraints and opportunities in graphical form. This serves to illustrate the key physical and contextual influences that need to be taken into account in the site's development. As such it is an essential precursor to design work, and an important tool in generating an imaginative and successful scheme. It should be an integral part of any development brief or urban design framework for the site or area.

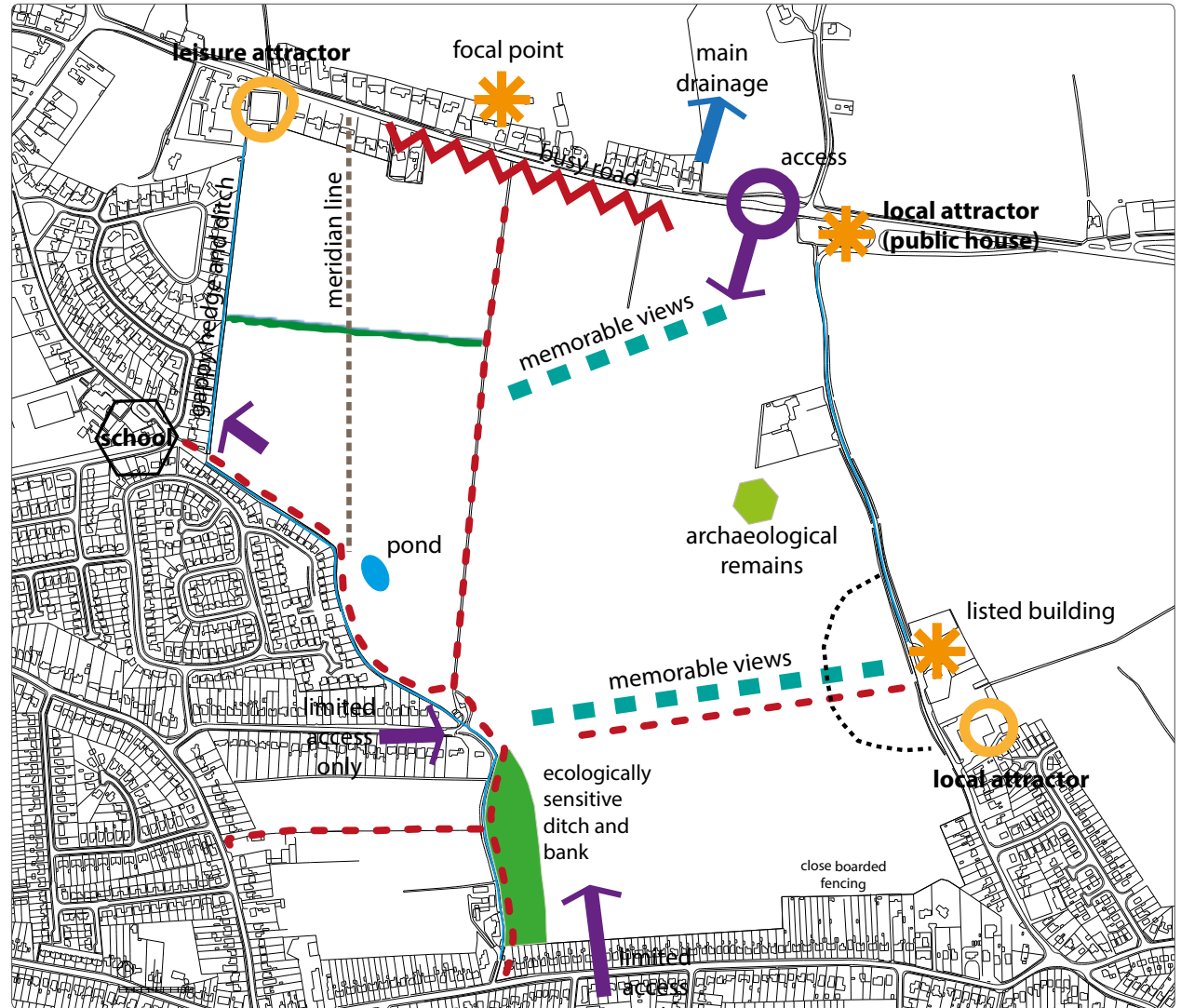

An example of a site appraisal diagram



THREE DESIGN CONCEPT

Step 3: Design Concept

Once a clear understanding of the site and its context has been achieved, a design concept should be developed which includes a strong vision for the site. This should consider:

- An understanding of the role of the development in contributing to the area’s character and the role it will play from a social, economic and environmental perspective.
- The aspects of the site’s setting that will influence the character of the development (e.g. townscape, density, land uses, street types and connectivity and block character).
- Features to be retained (such as trees, hedgerows, ponds, drains and streams or existing buildings) that will add to the local distinctiveness of the development whilst bringing their own particular opportunities for place making.
- How elements of the development can work with setting and site features.
- How ease of access for pedestrians and cyclists will be achieved as well as access by a range of transport modes.
- Use of materials that reflect the local area and reduce impact on the environment and energy resources.
- Provision of space to contribute to residential amenity, recreation, wildlife and water opportunities to link to the existing green infrastructure network.
- Any space requirements for servicing, including access, collection, delivery, recycling and storage.
- Parking provision that does not dominate the public realm.
- How development will be safe and secure for users.

Pre-application discussions with Council should be held as part of this stage, particularly if they have not been held at previous steps. Depending upon the scale and sensitivity of the scheme, an initial independent design review may be worthwhile.

For larger and more sensitive sites a master plan will be required to inform the development of any design concept.



Design Concept Diagram

The design process for large, complex or sensitive sites is likely to require a variety of illustrative material as work proceeds. A concept diagram illustrates the key principles that will shape the detailed design of the site. It builds upon the site appraisal, showing how the development can respond to the constraints and opportunities present on the site and in its surroundings. It suggests the overall form that the development might take, without going into detail.

The site concept diagram is a key stage in the process leading to the final design, as well as an important means of conveying initial ideas about how the site or area can be developed.

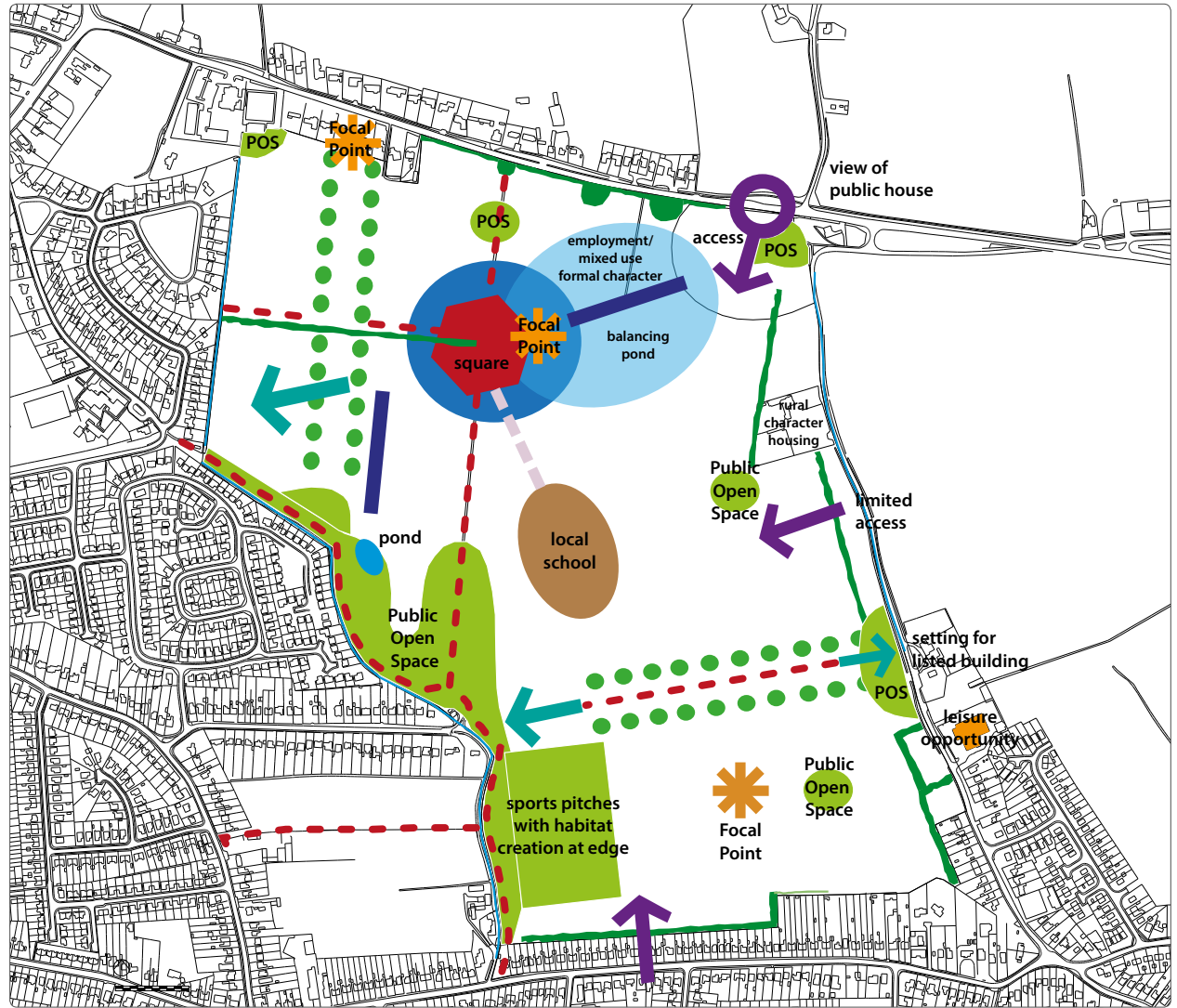

An example of a site concept diagram



FOUR

THE PROPOSAL

Step 4: The Proposal

An iterative process of design development should take place for this stage. This will be particularly relevant for master planned schemes or outline planning applications for large sites but will have value for all development proposals.

For this stage, the following parameters should be decided upon:

- Density and land uses
- Access and movement
- Block structure and public realm
- Parking and servicing
- Building forms and public realm

These parameters may be required to form the basis for an EIA.

Further pre-application discussions with the Council and design review should take place during this stage to refine the scheme.

For larger schemes the Council will also expect pre-application public consultation to take place.





Develop a Masterplan

In the case of large sites the preparation of a masterplan may be necessary to bridge the gap between broad ideas (as set out in the concept diagram) and the production of plot-specific layouts. A master plan sets out the proposed spatial structure of the scheme, including the arrangement of roads, street blocks and open spaces, and indicates the uses to which different areas will be put. It builds upon the ideas expressed in the concept diagram, and may also be accompanied by details of how the site's implementation is to be programmed.

Whether a master plan is included in a development brief or urban design framework depends upon the level of detail appropriate for the site or area concerned; it is not possible to be prescriptive about this, as much depends upon the spatial and development context.



An example of a master plan for a site, showing how the urban structure has been developed





FIVE

MAKING THE APPLICATION

Step 5: The Application

The information required for a planning application will vary depending on the type and scale of development. Prior to making the planning submission applicants must ensure that sufficient drawings and supporting documents have been prepared in accordance with the Council’s requirements.

Below is a list of documents that may be required to support the application and to articulate the design process:

1. Design and Access Statements: The majority of planning applications must be accompanied by a Design and Access Statement (DAS). The DAS plays an important role in describing scheme proposals and to illustrate the process of design, including a record of the decisions undertaken in the evolution of proposals. This should include details of the site analysis and appraisal, and how development proposals have responded to consultation comments.
2. Design Codes: This will be a requirement for all large scale major development proposals at the Outline application stage

(often considered via condition stage). The design code will set out detailed principles to be applied to particular aspects of the design to be applied through subsequent Full or Reserve Matters applications, such as landscaping, highways, building frontages etc.

3. Master plan: This should provide a clear indication of the layout of development. It may be illustrative in the case of outline planning applications, and should provide a clear indication of the principles of development. In the case of an outline application, this may be required by planning condition.
4. Sustainability Assessment: How social, environmental and economic sustainability principles are achieved in the scheme.
5. Environmental Statement: Where required to assess the potential environmental effects under the EIA regulations.

A good application will be concise, specific and outline clearly the factors shaping the design. It will also incorporate accurate and informative visualisations to clearly explain the proposals.





Pre-Application Design Process

It is important to engage with the planning authority at the outset and at key project milestones throughout any project. This will help develop a relationship which should ultimately lead to a more efficient process and desirable design solution.

There are different pre-application advice services available from the Council depending on the size and scale of development proposed. Advice for household extensions and alterations to Listed Buildings can be found [here](#) on the HDC website. For all other types of development the Council encourages pre-application discussions which can be a combination of meeting and or written advice. Further details on the pre-application process can be found on the HDC website [here](#).

At the start of negotiations the applicant and the Council may be some way apart when it comes to agreeing an acceptable solution to a development. An applicant may present a ‘viability layout’ without assessing the context or design requirements of that site. However, this should not usually form the basis for negotiation, and a site visit should often be the

first element of any successfully negotiated proposal.

Depending on the scale of the site and/or complexity of the project it will be helpful to include three dimensional axonometric and artist impressions portraying the scale and massing of what the finished project will look like.

The inclusion of photos of other projects and instances in Huntingdonshire or of comparable places are also useful tools in supporting planning applications.

As advocated in the NPPF, the Council will encourage schemes to be the subject of independent design review, depending upon the scale or sensitivity of the proposal.

On the next two pages, two examples are shown where the final approved scheme bore no resemblance to earlier proposals. One example was for an infill redevelopment of 25 houses, and the other example was of a development of 80 houses built as part of a larger urban extension development.





Redevelopment of brownfield site, Brampton

1. This small site in Brampton was previously a garage. Initial discussions were based round an uninspiring standard road design with a turning head at the end, with 9 detached houses facing each other. This proposal did not create a sense of place, nor did it actively engage with Thrapston Road.
2. The second version increased the number of dwellings but kept the same design concept. This scheme was refused because of poor design.
3. The final higher density version successfully dealt with four important design issues:-
 - it actively faced onto Thrapston Road
 - a shared space was created inside the site
 - scale changes were made to reflect the context of the site
 - the building elevations were articulated in a pleasing and well considered way

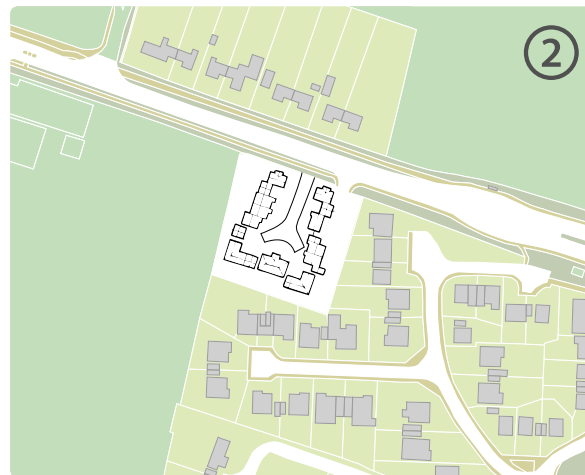
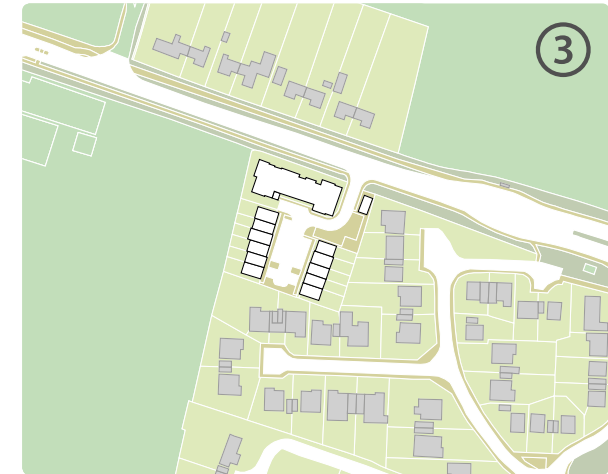
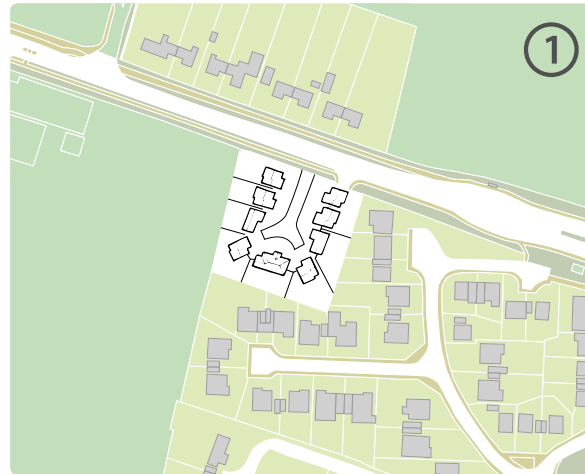

Changes in scale to deal with potential neighbour amenity - Brampton





Greenfield residential extension, Cambourne

1. This large site was part of a much larger development, linking in to other sites that were already under construction. This first attempt was very poor. This was a viability layout which needed a fundamental rearrangement to make it acceptable.
2. The layout was completely changed to enable more pedestrian connections to the wider area, the creation of more enclosed and attractive spaces, and the arrangement of the streets and buildings to be more legible.

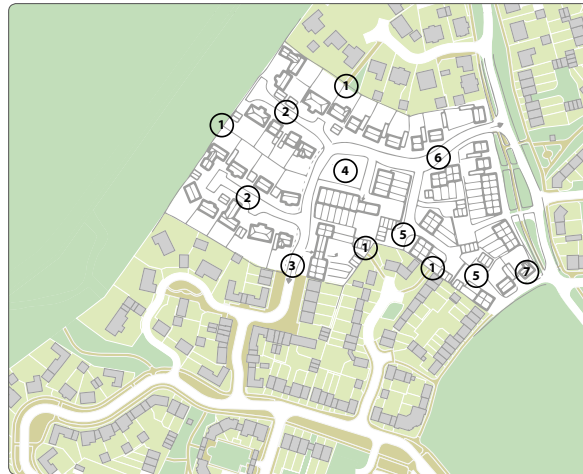

Key

- ① Lack of connections to wider area
- ② Unimaginative street design
- ③ Opportunity to create an attractive space with neighbouring development not taken
- ④ Dull design of open space
- ⑤ Complicated car court design
- ⑥ Buildings do not follow street
- ⑦ Prominent location not utilised for a key building

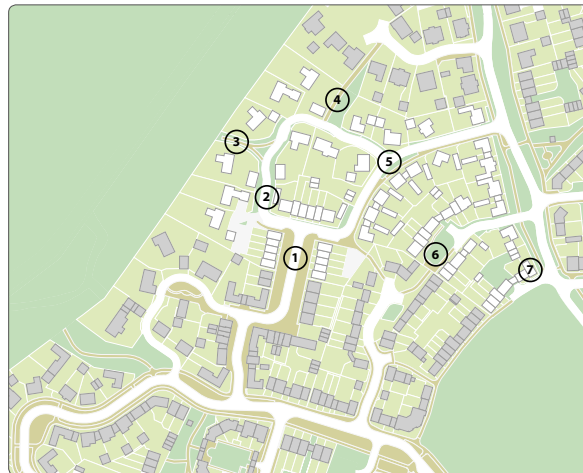

Key

- ① Creation of attractive public realm
- ② Rural lane
- ③ Pedestrian connections to wider network
- ④ Pedestrian connections to adjacent housing areas
- ⑤ Buildings to follow street
- ⑥ Routes and spaces linked to adjacent development
- ⑦ Focal building in prominent location

B

H

←

The use of street trees helps to define car parking spaces - Cambourne

→



Development scenarios

The Council is committed to facilitating a high standard of design in order to achieve high quality places to live, work and visit.

The rest of this chapter highlights examples of successful developments of various sizes and types in or around Huntingdonshire.

With each size or type of development comes a series of questions that applicants should be thinking about, setting out how the place making principles and design objectives can be achieved for the type of development in question.

Each of the six scenarios looks at a common type of development proposal:

Scenario One

Large Scale Development

Scenario Two

Infill and small groups

Scenario Three

Single Homes

Scenario Four

Extensions and Alterations

Scenario Five

Homes with care provision

Scenario Six

Non-residential Development





4.3 Scenario One

Large Scale Development

Huntingdonshire will see the development of over 21,000 new homes in the period up to 2036, many of which will be accommodated on large scale major mixed use developments of over 200 homes.

Major development of smaller size below 200 homes is likely to deliver a notable proportion of housebuilding within the district. This is likely to be adjacent or within existing towns or villages. It will be important for such developments to respect and integrate the streetscene, and landscape and create an cohesive community with existing residents.

This section sets out how those drawing up such proposals should apply the place making principles and design objectives in order to achieve the necessary quality of design. The questions over the next few pages deal with the particular issues that are likely to occur on large scale development. If addressed comprehensively they will enable developers, designers and consultants to bring forward schemes. Close liaison with the Council is recommended.

At the end of this section are two examples of development, one being large scale major at Loves Farm St Neots, the second being a development of 55 dwellings as part of the Oxmoor regeneration plan, Huntingdon.

B

H

←

→



Questions to consider

Large Scale Development

This section provides a series of questions relating to the design requirements for large scale development that should be considered through the design process.



Has an adequate amount of amenity space been provided for each residential unit and is it of a shape, size and location to allow effective and practical use by residents?

1. Developing the Scheme

1.1 Has a step by step process been undertaken including a site appraisal and its setting and design evolution?

2. Site Context

2.1 Has the proposal been developed through a clear understanding of the site constraints, opportunities and surrounding context?

2.2 Has a thorough site appraisal and analysis been undertaken that fully explores the site's potential and demonstrates how this has influenced the design and layout of the development?

2.3 Has the impact of the development's scale and massing with neighbouring properties been considered?

2.4 How will the proposed development impact and mitigate on the ecological habitats of the site and existing trees and hedgerows. the proposed development have any impact on the ecological habitat of the site?

2.5 Have buildings and structures of historical importance including Conservation Areas, Listed Buildings, Buildings of Local Interest and archaeological remains been considered?



3. Land Use and Density

- 3.1 Has an appropriate mix of land uses been proposed including a range of housing types and tenures and services to support community requirements?
- 3.2 Does the land use and density proposed accord with any site specific development guidance for the site.
- 3.3 Do proposed land uses and density reflect the surrounding context?
- 3.4 Do proposals on sites within or in close proximity to town or village centres include a level of commercial, leisure or retail development with residential uses above?
- 3.5 Does the proposed density ensure that appropriate privacy, safety and security, daylight, sunlight and parking requirements can be met?

B

H

←

4. Access and Movement

- 4.1 Do proposed routes provide clear and direct connectivity across the site and surrounding areas?
- 4.2 Have existing public rights of way been incorporated into the movement network?
- 4.3 Have streets been designed in accordance with the street typologies and hierarchy of movement as discussed in Section 3.3?
- 4.4 Are all non-residential uses accessible from the primary street network
- 4.5 Has appropriate provision been made for accessibility by pedestrian and cyclists?
- 4.6 Have the accessibility requirements of people of all ages and abilities been considered?

- 4.7 Are all non-residential uses accessible from the primary street network?

5. Block Structure

- 5.1 Are the blocks appropriate in scale to the type of use proposed?
- 5.2 Does the proposed block structure reflect the wider urban grain, massing and density?
- 5.3 Are the blocks designed to maximise street frontage and enclosure along key streets?
- 5.4 Are building heights and massing considered from the outset?
- 5.5 Has consideration been given to appropriately located feature buildings and landmarks within the overall block structure?

→



- 5.6 Do proposals demonstrate an efficient block structure, and provide active frontages over public open space?
- 5.7 Have “big box” activities (for example supermarkets,) been integrated into their surroundings by wrapping with active uses including small-scale retail, office and residential activities?

6. Landscape, public realm and amenity space

- 6.1 Has a comprehensive approach to landscape and public realm been taken that incorporates existing site features, such as water courses, hedgerows and trees and safeguards existing ecology on site?
- 6.2 Has the potential for creating strategic landscape links within and beyond the site been explored?



- 6.3 How will the public realm areas be enhanced by new, high quality hard and soft landscaping?
- 6.4 Have water sensitive design principles, including provision for sustainable drainage systems been considered?
- 6.5 Has the layout design included the provision of areas of public open amenity space of different scales across the site, including play spaces.
- 6.6 Are play areas located in accessible locations through the site and overlooked by adjoining buildings? Has the location of play areas considered the likely impacts of noise and lively activity, and do they receive maximum amounts of sunlight?

- 6.7 Have water sensitive design principles, including provision for sustainable drainage systems been considered as an integral part of the development’s open space network?
- 6.8 Has an adequate amount of amenity space been provided for each residential unit and is it of a shape, size and location to allow effective and practical use by residents?

7. Building Form

- 7.1 Does the building form create attractive and high quality places where people want to live and work?





- 7.2 Do proposals take into consideration the location and setting of houses and apartment blocks in the context of the site, streetscape, landscape, block typology and adjoining land uses?
- 7.3 Is an appropriate housing typology considered (i.e. detached, semi-detached, apartment etc.) given site density and location?
- 7.4 Have prominent buildings been located on street corners, or at the termination of long range views?
- 7.5 Has the need for privacy between properties and from the street considered?
- 7.6 Do buildings make the most of the benefits of daylight and sunlight? Has there been a regard to micro-climate?



8. Parking and Servicing

- 8.1 Has a parking strategy been produced for the site which has been influenced by the outcomes of a transport strategy and other evidence of parking requirements?
- 8.2 Is a range of parking solutions proposed and is it conveniently located for all uses on the site?
- 8.3 Does on-street car parking minimise the impact on the wider public realm?
- 8.4 Have all refuse and servicing requirements been addressed?

9. Details

- 9.1 Has a generic approach to development been avoided with every effort made to embrace the principles of local distinctiveness?

- 9.2 Does the architecture respond to the surrounding site context, including existing buildings or landscape character?
- 9.3 Have local building materials, details and colours been followed?
- 9.4 Have bin storage areas, pipe work services and utility boxes been concealed within the building form?

10. Phasing

- 10.1 Has an appropriate phasing and construction strategy been produced that coordinates with the provision of infrastructure delivery?





Bringing it all Together

Large Scale Development Examples

The following two examples illustrate how large scale developments can achieve high quality design which are based upon the design process and considerations for this scale of development as detailed below.

Example 1: Loves Farm, St Neots Urban Extension

Loves Farm provides an example of a large urban extension to St Neots. The urban extension accommodates over 1400 dwellings together with a large primary school, community building, nursery and convenience retail shopping. The site also accommodates the relocated St Neots football club grounds which was delivered at a very early stage in development. The site was brought forward under an outline planning application originally based upon an urban design framework which identified the key features of the site including existing water courses and areas of trees for incorporation within the layout. The adjoining railway station at St Neots was a key influence upon the overall layout of the development and a series of pedestrian and cycle connections across the site to the railway station where a

new access to the station from the development was provided. A detailed Design Code was produced for the site in collaboration with the Council.

This example adheres to some of the principles contained within the Design Guide.

This example adheres to many of the design principles contained in this guide. These principles include:

- Full site assessment, appraisal of existing features and context of the site.
- Land uses, with primary school located within the centre of the site for accessibility by all residents. Location of retail and community building adjacent to the railway station for maximum footfall.
- Northern and eastern edges of the site encompassing landscape buffer with informal recreation.
- Higher density development around the railway station and main vehicular routes into the site. Lower density development along the fringes of the site.



Loves Farm, St Neots





- Bus route within the site with a bus gate at the northern end of the development.
- Good cycle and pedestrian routes throughout the site and connecting to the wider area.
- Block structure designed to provide key frontages to street and open spaces.
- Linked network of open spaces across the site, and good provision of children’s play at a variety of scales and locations.
- Strong character areas of development across the site, corresponding with building densities, including strong contemporary adjacent to the railway station, though to Village Green characters and soft contemporary along the fringes of the site.
- Key buildings located on principle streets with attractive elevation detailing.
- Range of architectural designs corresponding with character areas, with good quality materials and simple architectural detailing.
- The development includes examples of good elevation symmetry and balanced composition with use of large windows.

- Generally good adherence to the Design code for the site, however there have been some shortcomings which include residents not using rear parking courts (due to lack of surveillance and sterile environments) and roads not wide enough to accommodate on street parking in certain locations.

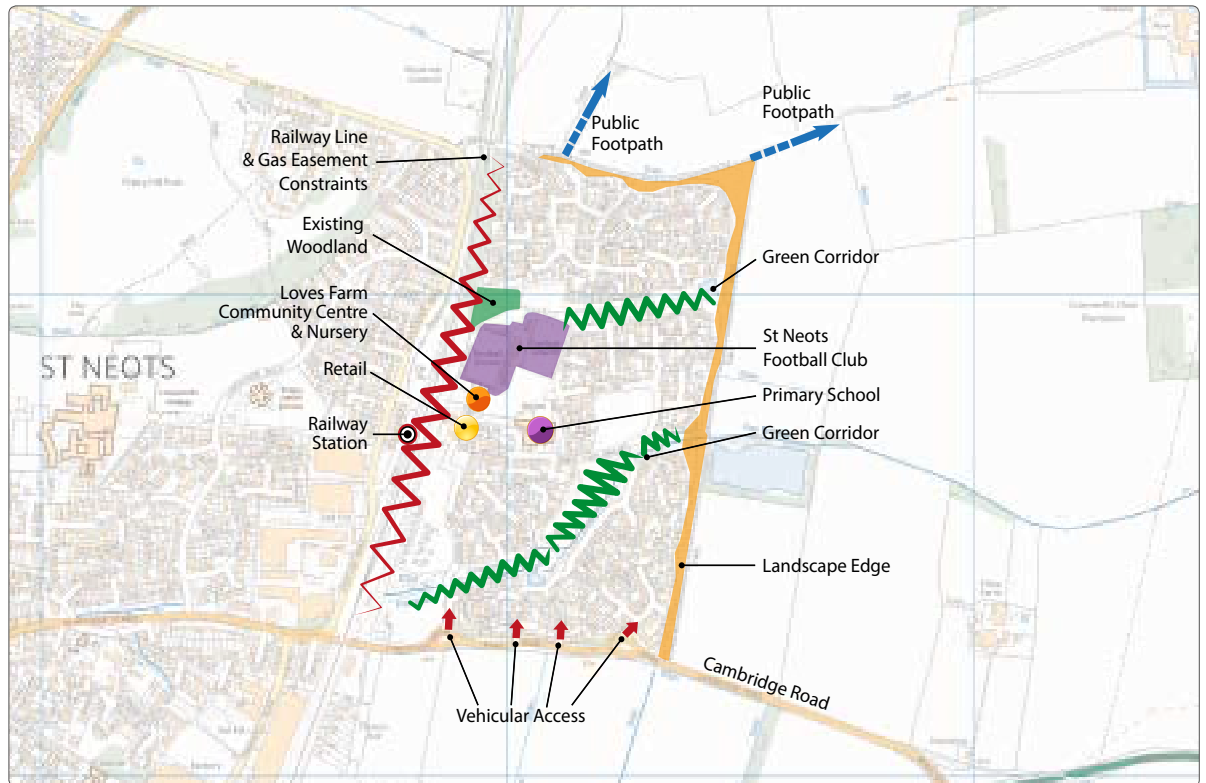

Loves Farm, St Neots

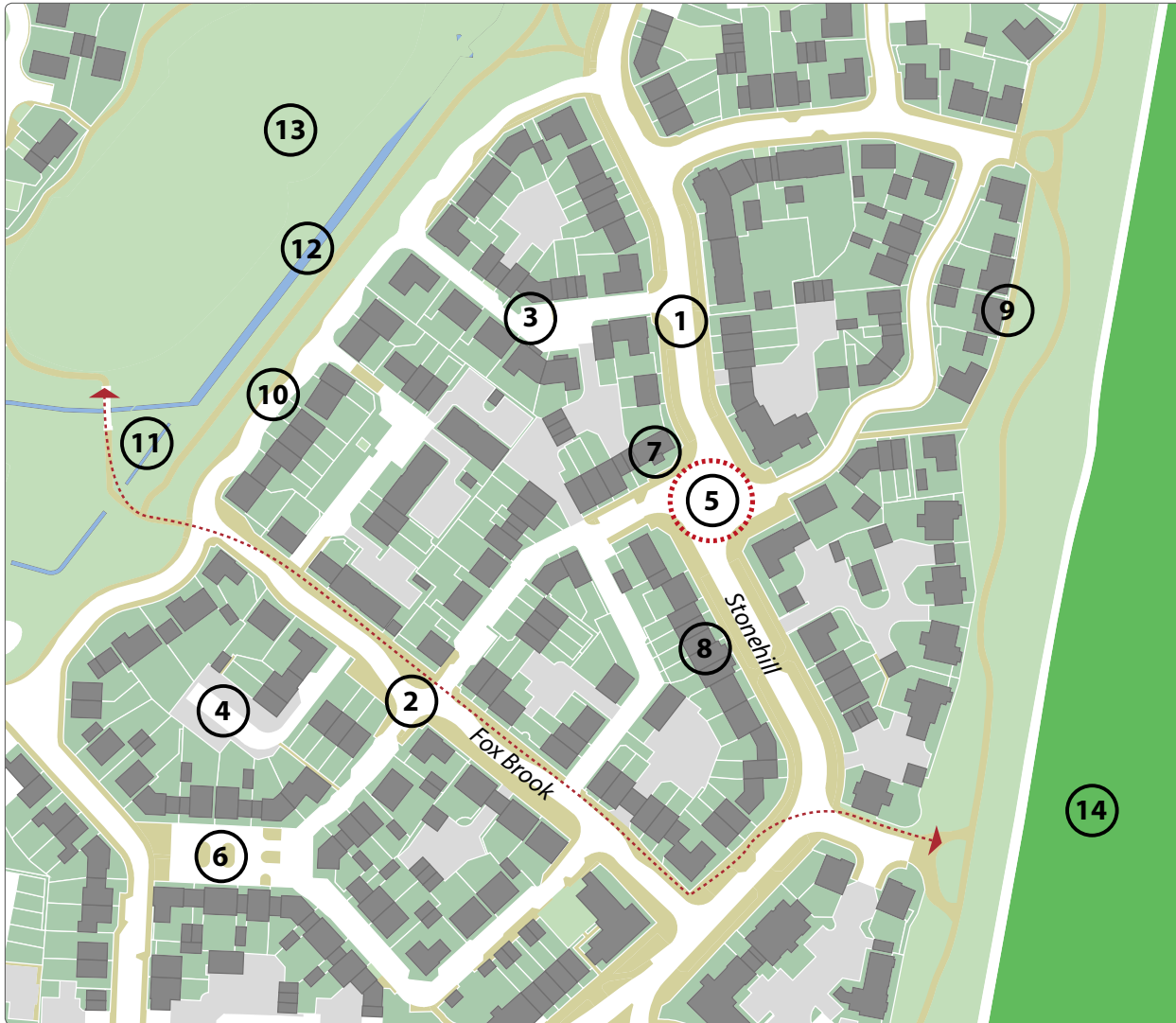

Key

- ① Primary street
- ② Secondary street
- ③ Mews street
- ④ Landscaped parking court
- ⑤ Key enclosed space
- ⑥ Secondary enclosed space
- ⑦ Focal building
- ⑧ Terraced buildings facing street
- ⑨ Buildings facing onto strategic landscaped belt on site fringe
- ⑩ Buildings facing onto strategic open space
- ⑪ Pedestrian and cycle route across the site
- ⑫ Existing watercourse and trees contained
- ⑬ Strategic open space doubling up as surface water attenuation area
- ⑭ Countryside beyond development site



Secondary street



Entrance to a shared surface mews street



This entrance to a rear car court is generously landscaped and the entrance is overlooked well



Big ground floor windows enliven this house



Key building





Example 2: Moorhouse Drive, Huntingdon

This development was built in the northern suburbs of Huntingdon, as part of the Oxmoor regeneration plan and comprises 55 dwellings. This site was previously used as informal open space with a play area. The play area was relocated adjacent to the site as part of the redevelopment.

The constraints on the site were:

- Some poorly maintained but attractive groups of trees on and adjacent to the site, including oak and elm.
- A few long distance pedestrian and cycle routes through and adjacent to the site.
- Adjacent residential properties.
- High voltage cables undergrounded through the site.

The development includes the following positive design outcomes:

- The maintenance of a clear network of pedestrian and cycle routes through the site.
- Well designed houses, with good quality detailing, note the deep windows, the timber cladding, and how the same house

design using different elevations creates more interest in the street scene.

- Good use of scale and form for the buildings, with the open space in the centre of the site overlooked by slightly taller houses. Many of the houses are narrow span, with the use of cranked form to create attractive spaces.
- A good feeling of enclosure with the buildings and spaces working well together.

Good quality hard and soft landscaping, with car parking on street providing a pleasing example of how a shared street/space can work well.



Moorhouse Drive, Huntingdon

Well designed houses, with good quality detailing





Examples of design features at Moorhouse Drive, Huntingdon

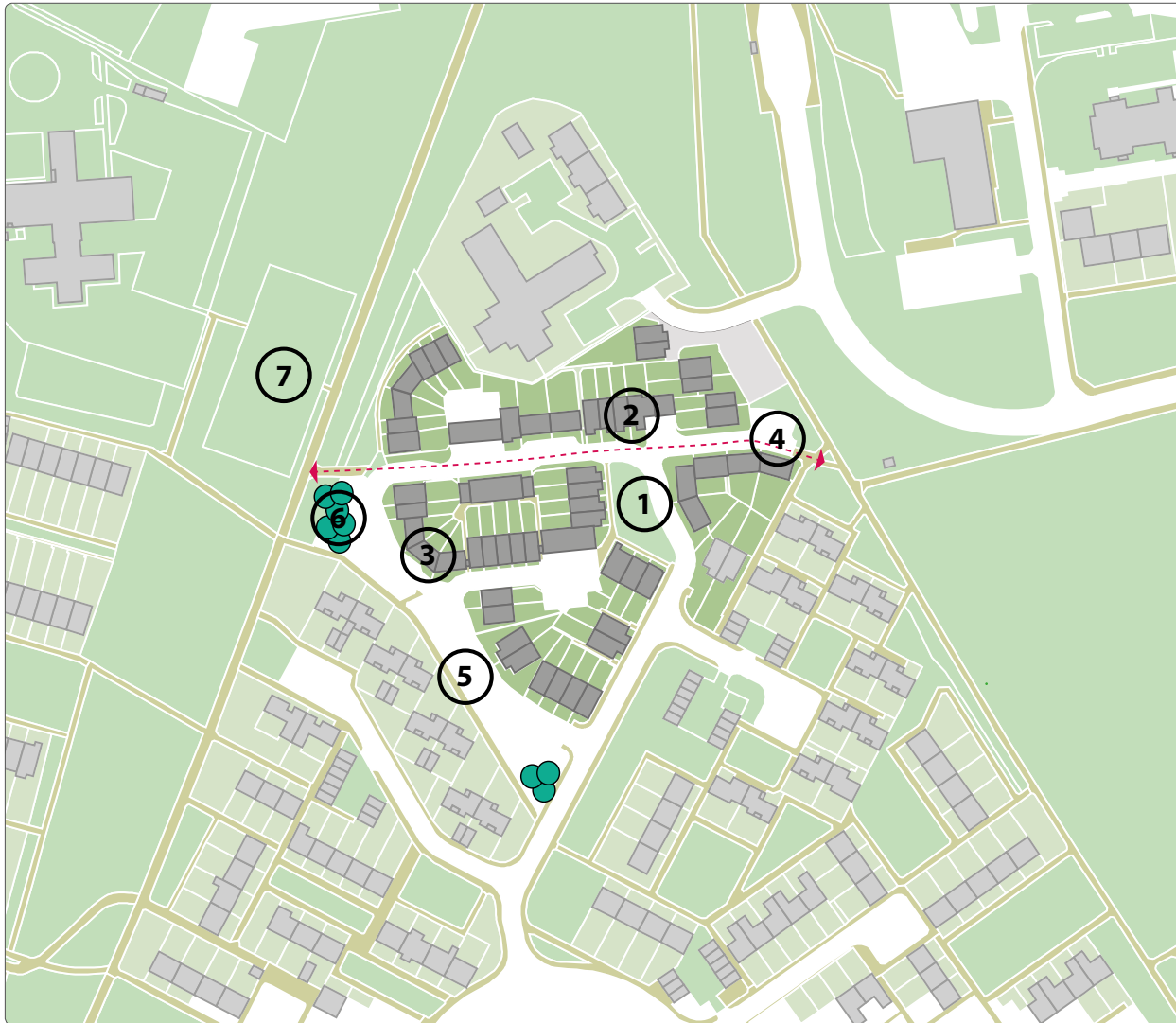

Key

- ① Key enclosed space
- ② Focal building
- ③ Buildings designed to turn corners
- ④ Reinforced existing permeable routes
- ⑤ Well designed car parking
- ⑥ Existing trees retained
- ⑦ Relocated play area



Extensive soft landscaping



High quality paving materials



Subtle car parking detailing



This building addresses the corner in a well designed manner



Buildings enclose space





4.4 Scenario Two

Infill and Small Groups

Infill and small groups of development generally consists of development on previously developed or underused land within towns or villages. This will typically comprise mixed uses including residential, retail, commercial and leisure uses. It will be important for such developments to respect and integrate the streetscene, and landscape and create an cohesive community with existing residents.

This section sets out how those drawing up such proposals should apply the place making principles and design objectives in order to achieve the necessary quality of design. The questions over the next few pages deal with the particular issues that are likely to occur on infill and small groups of development. If addressed comprehensively they will enable developers, designers and consultants to bring forward schemes. Close liaison with the Council and Town / Parish Councils is recommended.

At the end of this section are four examples of development with constraints including listed buildings, conservation areas and tree preservation orders.



Small group under construction in St Ives



Questions to Consider

Infill and Small Groups

This section provides a series of questions relating to the design requirements for infill and small groups that should be considered through the design process.

1. Developing the scheme

- 1.1 Has a step by step process been undertaken including a site appraisal and its setting and design evolution?
- 1.2 Does the proposed development demonstrate an understanding of the existing “urban grain” i.e. the layout and length of streets, nearby open spaces, road and pavement widths, size and shape of housing plots, boundary presence and landscape?
- 1.3 Does the proposed development replicate adjacent building setbacks?

- 1.4 Have adjacent building heights, floor to ceiling heights, fenestration, eaves and ridge lines been considered? If a consistent pattern is prevalent then this should be reflected in the new development. If a more varied pattern exists then more flexibility may be possible.

2. Site Context

- 2.1 Does the proposed development demonstrate an understanding of the character and context of the existing urban pattern i.e. the layout and length of streets, nearby open spaces, trees, road and pavement widths, size and shape of housing plots, boundary presence and landscape?

- 2.2 Have buildings and structures of historical importance including Listed Buildings, Buildings of Local Interest, Conservation Area and archaeological remains been considered?
- 2.3 Have potential impacts on / from neighbours / surrounding development been taken into account? (Impacts include loss of light and privacy, overlooking, loss of amenity space, noise and disturbance or overbearing).

3. Land use and density

- 3.1 Are proposed land uses sympathetic with the surrounding context?
- 3.2 Do proposals on sites within or in close proximity to town or village centres include a level of commercial, leisure or retail development with residential uses above?

B

H

←

→



- 3.3 Is the proposed building density sympathetic to the adjacent densities of development?
- 3.4 Does the proposed density ensure that appropriate amenity levels and parking to serve the development can be met?

4. Access and movement

- 4.1 Do proposals make use of existing access points and street hierarchy?
- 4.2 If new access points are proposed are they convenient for future users of the site and neighbouring development?
- 4.3 Do all proposed routes provide clear network across the site which integrate with surrounding routes?
- 4.4 Has accessibility for pedestrian and cyclists been prioritised within the development?



- 4.5 Have existing public rights of way been sufficiently incorporated within the development?
- 4.6 Where new streets or spaces are proposed do they reflect the surrounding pattern of development?

5. Block structure

- 5.1 Have any existing buildings of value been retained and included within the proposal, including listed buildings?
- 5.2 Does the proposed block structure reflect the surrounding pattern, massing and density of development?
- 5.3 Are the blocks designed to maximise street frontage and provide active frontage over the public realm?

6. Landscape, Public Realm and Amenity Space

- 6.1 Have existing site features such as hedgerows, trees and boundary walls been retained and incorporated within the scheme?
- 6.2 Does new planting assist in reinforcing local distinctiveness and is native planting appropriate?
- 6.3 Has sustainable drainage been included within the development?
- 6.4 Do hard surfaces incorporate high quality paving materials to create a high quality public realm?
- 6.5 Does the proposal provide high quality public realm through tree and shrub planting, street lighting, street furniture, public art and / or other landscaping features?





6.6 Has an adequate amount of amenity space been provided for each residential unit and is it of a shape, size and location to allow effective and practical use by residents?

7. Building form

7.1 Does the building form create an attractive and high quality place.

7.2 Do proposals take into consideration the location, setting and building mass of houses and apartment blocks in the context of the site, streetscape, landscape and adjoining land uses?

7.3 Is an appropriate housing typology considered (i.e. detached, semi-detached, terraced, apartment etc.) given site density and location?

7.4 Have prominent buildings been located on street corners, or at the termination of long range views?

7.5 Is the need for privacy between properties and from the street considered?

7.6 Does the position of buildings make the most of the benefits of daylight and sunlight? Has there been a regard to micro-climate?

8. Parking and servicing

8.1 Has car parking been designed so as not to dominate the entrance to the site and its street frontage?

8.2 Has the design and layout of parking areas been considered as part of an overall landscape and public realm strategy for the site?

8.3 Has secure and sheltered cycle parking provision been provided in convenient locations?

8.4 Where appropriate, has a range of car parking solutions in convenient locations been accommodated to maximise the potential for the site?

8.5 Have all refuse and servicing requirements been addressed?

9. Details

9.1 Has a generic approach to development been avoided with every effort made to embrace the principles of local distinctiveness, creating different character areas across the site?

B

H

←

→



- 9.2 Does the architecture and building mass respond to the surrounding site context, including existing buildings or landscape character and have local building materials, details and colours been followed?

- 9.3 Have appropriate high quality boundary treatments been incorporated and have they taken into account the prevailing character of the area?

- 9.4 Have details such as bin storage areas, pipe work services and utility boxes been incorporated within the building form?





Bringing it all Together

Infill and Small Group Examples

The following four examples illustrate how different infill developments can achieve high quality design which are based upon the design process and considerations for this scale of development as detailed below.

Example 1: Temple Place, Huntingdon

This development was built on the site of a former laundry, adjacent to an attractive planned Victorian suburb built on a grid pattern with a central public garden. The site was developed in two parts.

The positive outcome to the site's development included:

- Buildings reflecting adjoining architectural character and use of materials
 - Variation of scale throughout the site reflecting adjacent development / location
 - A broad mix of housing tenures
 - Within walking / cycling distance to town centre
 - Mix of parking solutions which do not dominate the street.
- Buildings and routes integrated with the existing formal pattern of the adjacent streets
 - Density of development appropriate taking account of existing development density and location
 - Block structure creating outward facing development onto existing and new streets
 - High quality public realm A broad mix of housing tenures



Temple Place, Huntingdon





Key

- ① New street connecting into existing street network
- ② Good variation of scale
- ③ Buildings to enclose space and engage the eye
- ④ Use of attractive buildings with deep bay windows
- ⑤ Retained access to office use creating a mixed use environment

Example of infill development, Temple Place, Huntingdon.



Variety in scale adds interest



High quality detailing



These buildings lead the eye along the street





Example 2, Two Sites at East Street, St Ives

These two sites within the town centre of St Ives reflect mixed use high density infill development. Both are located within the Conservation Area. Both sites are highly constrained due to their shape as well as factors such as flood risk.

Site A. – Crown Street Mews.

This development was built on the site of a former garage which contains a listed building. The development included a mix of uses with two office units on the front and 13 residential to the rear each with one car parking space.

The positive outcomes to the site’s development included:

- Retention and reuse of existing listed building as residential unit.
- Development reflecting the built form of the area (linear burgage plots) and creating a pleasant internal courtyard for residents.
- Density of development appropriate taking account of existing development density and location.
- Block structure creating outward facing development onto existing street and new



courtyard.

- High quality public realm with trees.
- Buildings containing a contemporary architectural character but with use of sympathetic materials to the locality.
- Variation of scale throughout the site reflecting adjacent development / location, with 3 storey on the site frontage and a mix of scales to the rear.
- A good variety of dwelling sizes.
- Within walking / cycling distance to town centre.
- Mix of parking solutions which do not dominate the courtyard, with some undercroft included.
- The use of architectural features that add interest and distinctiveness to the development.
- Two office units converted into a dentist surgery on the front.

Site B – St Legers Mews.

The site was a former printers which contained a number of buildings and a converted Victorian dwelling (in office use) at the front of the site. The development included the first floor conversion of the former office building and 7 new dwellings to the rear. This is a car free development.

The positive outcome to the site’s development included:

- Reuse of existing building to the front as a mix of uses.
- Development reflecting the built form of the area (linear burgage plots) and creating a defined linear space.
- Density of development appropriate taking account of existing development density and location.
- Block structure creating outward facing development onto existing street and new linear space.
- High quality public realm.
- Buildings containing a contemporary architectural character but with use of sympathetic materials to the locality.





- Variation of scale throughout the site reflecting adjacent development / location with the design mitigating flood risk.
- A good variety of dwelling sizes.
- Within walking / cycling distance to town centre.
- Car free development but with good provision of secure, covered cycle parking.
- The use of architectural features that add interest and distinctiveness to the development.
- Bin storage in convenient yet discrete locations.

Key

- ① Active frontage
- ② Mix of uses
- ③ Reinforce burgage plot
- ④ Listed Building enhanced
- ⑤ Enclosed space
- ⑥ Existing permeability
- ⑦ Focal building



High density infill development, Crown Street Mews and St Legers Mews, St Ives





Site B: Reinforcing the burgage plot



Site A: High quality materials and overall architectural design



Site A: Focal listed building (right) at the end of the development, high quality public realm and on site parking.



St Ives, Cambridgeshire





Example 3: Scotts Close, Hilton

This development was built on the part of the former grounds belonging to Hilton Hall, in the centre of the village of Hilton. There are many trees containing a Tree Preservation Order on the site, which provides an important characteristic of the site. The site is also within Hilton Conservation Area and adjacent to a number of listed buildings. The development comprises of 9 detached dwellings.

The positive outcomes to the site's development included:

- Successful retention of existing trees on site
- Low density development appropriate to the constraints and location of the site with generous plot sizes
- Outward facing development onto existing street and new private drive
- A variety of scale with 2 and 1.5 storey dwellings together with single storey garage buildings providing an attractive visual arrangement
- A high quality of design with deep windows, and attractive use of sympathetic materials including render to the

development and sites location

- Generous front gardens and high quality estate rail boundary treatment with lots of space to enable the existing trees to flourish
- Within walking / cycling distance to village amenities
- On plot parking.



Scotts Close, Hilton



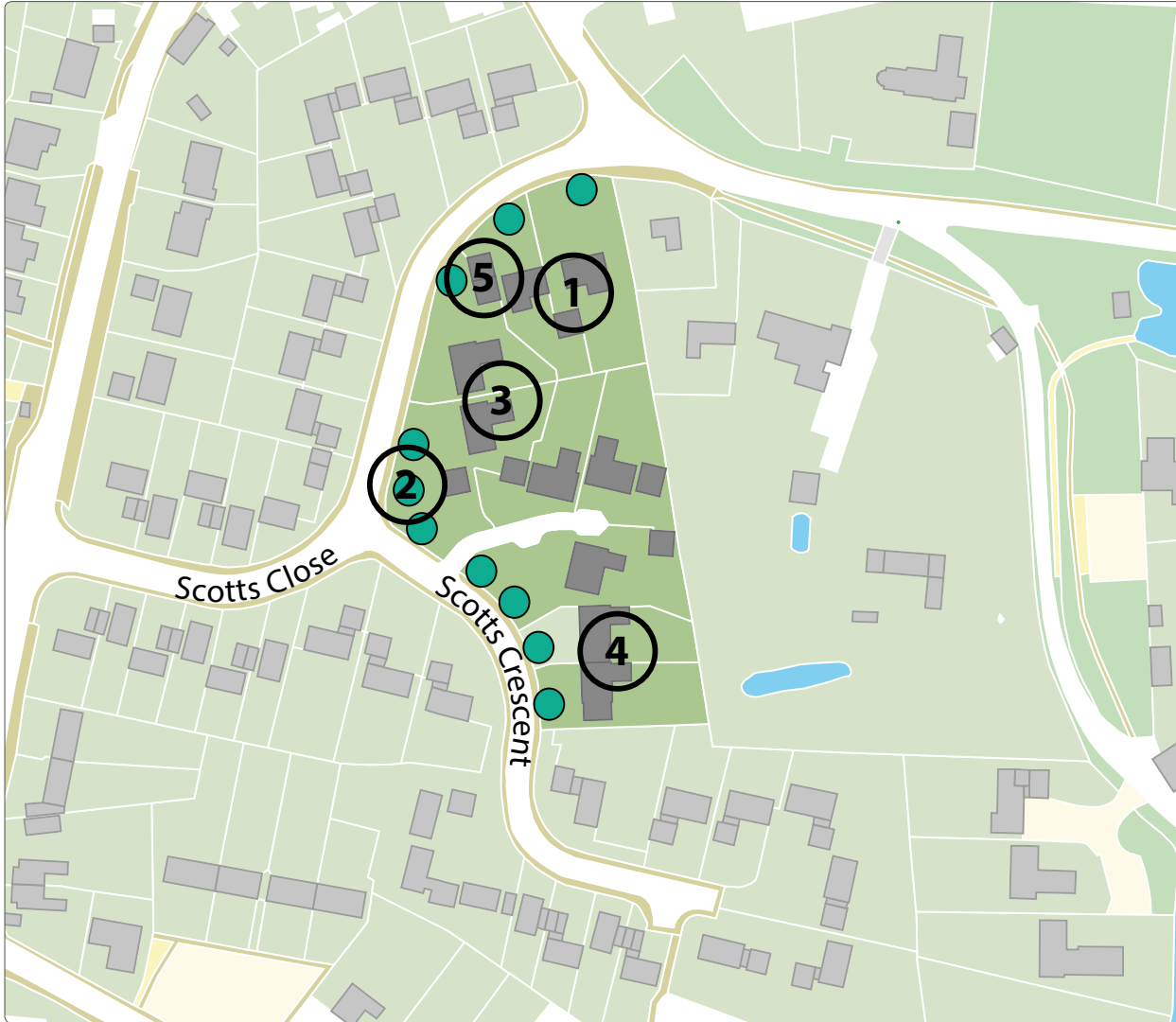

Key

- ① Locally distinctive design
- ② Retention of protected trees
- ③ Appropriate low density
- ④ Variety in scale
- ⑤ Garages work as attractive outbuildings

Low density infill development, Scotts Close, Hilton



Use of good quality materials to provide strong sense of place



Good use of render



Attractive proportions and scale



Generous plots with deep windows and good use of render





Example 4: Church Street, St Neots

This development was on a former tyre garage site on the edge of the town centre in St Neots. The site is adjacent to Hen Brook, and within St Neots Conservation Area and surrounded by listed buildings. The site contains an existing 4 storey former industrial building and feature chimney tower. The development comprised the reuse of the industrial building to 3 apartments and an office unit, and 8 new build apartments, 6 dwellings on the site and a boat dock for residents. The development followed the principles of a design brief for the site which was produced by the Council.

The positive outcomes to the site's development included:

- Reuse of existing former mill building as a mix of uses.
- Reinstatement of water side development reflecting original scale of building on this part of the site. The corner of the building is contemporary in appearance with interest and distinctiveness.
- Retention of feature chimney tower and successful incorporation into the development.

- New building frontage to Church Street reflecting the built form, architecture and materials of the area.
- Density of development appropriate taking account of existing development density and location.
- Block structure creating outward facing development onto existing street and Hen Brook with an internal parking court.
- High quality public realm.
- Variation of scale throughout the site reflecting adjacent development / location with the design mitigating flood risk.
- A good variety of dwelling sizes.
- Within walking / cycling distance to town centre.
- Parking at a ratio of one space per dwelling and good provision of secure, covered cycle parking.
- Development minimising impacts on adjacent Listed Building.
- Bin storage in convenient yet discrete locations.



Church Street, St Neots





Key

- ① Restore street scene with residential dwellings
- ② Retention of landmark chimney tower
- ③ Feature corner of development, contemporary design in contrast to other buildings on the site
- ④ Reinstatement of waterside development, outward facing
- ⑤ Refurbishment and reuse of existing mill building

Creation of strong built form, Steam Flour Mill, Church Street, St Neots



Residential scale of development fronting street



View from the bridge



Reuse of former mill building and reinstatement of 3 and 4 storey development adjacent to Hen Brook



Retention of chimney in new development





4.5 Scenario Three

Single Dwellings

Single dwellings are most likely to constitute infill plots on previously developed or underused land within towns or villages. It will be important for such developments to respect and integrate with the streetscene, landscape, respect important vistas within and view out of streets and settlements, whilst also creating new views which add to the variety and character of a town or village.

Proposals for single dwellings must respect their surroundings, but that does not mean that the new development should necessarily be pastiche or attempt to mimic historic styles. High quality design is the most important factor, and a contemporary solution that at the same time considers the scale, materials, grain and elevational rhythm of its surroundings may provide a better solution. Today's high-quality buildings are tomorrow's heritage.

What may be a difficult site to develop, could generate innovative design solutions and architectural excellence.

B

H

←

Ancillary buildings include garden buildings, garages, stables and boathouses. They should generally be subservient to the main building.

This section sets out how those drawing up such proposals should apply the place making principles and design objectives in order to achieve the necessary quality of design. The questions over the next few pages deal with the particular issues that are likely to occur on single dwellings. If addressed comprehensively they will enable developers, designers and consultants to bring forward schemes.

At the end of this section are two examples of development with constraints including conservation areas, tree preservation orders and topography.

→

Questions to consider

Single Dwellings

This section provides a series of questions relating to the design requirements for infill and small groups that should be considered through the design process.

Site context

Does the proposal relate to the character and context of the surrounding area?

Has consideration been given to existing features which could influence the design, such as trees, nearby listed buildings and further away landmarks and vistas?

Have potential impacts on neighbours been considered? Impacts include loss of light and privacy, overlooking, loss of amenity space or overbearing impact?

1. Developing the scheme

- 1.1 Has a step by step process been undertaken including a site appraisal and its setting and design evolution?

2. Site Context

- 2.1 Does the proposed development demonstrate an understanding of the character and context of the existing urban pattern i.e. the layout, open spaces, trees, road and pavement widths, size and shape of housing plots, boundary presence and landscape?
- 2.2 Has consideration been given to existing features which could influence the design, such as trees, nearby listed buildings and further away landmarks and vistas?
- 2.3 Have potential impacts on / from neighbours / surrounding development been taken into account? (Impacts include loss of light and privacy, overlooking, loss of amenity space, noise and disturbance or overbearing impact).

3. Land use and density

- 3.1 Is the proposed building density sympathetic to the adjacent densities of development?
- 3.2 Does the proposed density ensure that appropriate amenity levels and parking to serve the development can be met?

4. Building detailing

- 4.1 Do proposals make use of existing access points?
- 4.2 If new access points are proposed are they convenient for future users of the site and neighbouring development?

B

H

←

→



5. Block structure

- 5.1 Have any existing buildings of value been retained and included within the proposal, including listed buildings?
- 5.2 Does the proposed dwelling and its location on site reflect the surrounding pattern, massing and density of development?
- 5.3 Does the dwelling maximise street frontage and provide active frontage over the public realm?

6. Landscape, Public Realm & Amenity Space

- 6.1 Have existing site features such as hedgerows, trees and boundary walls been retained and incorporated within the scheme?

- 6.2 Does new planting assist in reinforcing local distinctiveness and is native planting appropriate?
- 6.3 Has sustainable drainage been included within the development?
- 6.4 Do hard surfaces incorporate high quality paving materials to create a high quality public realm?
- 6.5 Has an adequate amount of amenity space been provided for each residential unit and is it of a shape, size and location to allow effective and practical use by residents?

7. Building Form

- 7.1 Does the building form create an attractive and high quality building?

- 7.2 Does the proposal take into consideration the location, setting and building mass of other development in the context of the site, streetscape and landscape?
- 7.3 Does the position of buildings make the most of the benefits of daylight and sunlight? Has there been a regard to micro-climate?
- 7.4 Has the proposal considered the following elements of building form?
 - Balance and harmony
 - Scale and massing
 - Turning a corner
 - Privacy and defensible space





8. Parking and Servicing

- 8.1 Has car parking and garaging been designed so as not to dominate the entrance to the site and its street frontage?
- 8.2 Has secure and sheltered cycle parking provision been provided in convenient locations?
- 8.3 Have all refuse and servicing requirements been addressed?

9. Details

- 9.1 Has a generic approach to development been avoided with every effort made to embrace the principles of local distinctiveness?
- 9.2 Does the architecture and building mass respond to the surrounding site context, including existing buildings or landscape character and have local building materials, details and colours been followed?
- 9.3 Have appropriate high quality boundary treatments been incorporated and have they taken into account the prevailing character of the area?
- 9.4 Has the following elements of building detailing been considered: Articulation, gable, roof, eaves and ridge lines, chimneys, utilities, doors, windows, balconies, hard and soft landscaping, thresholds, materials for the walls and rood, ecological enhancement.





Bringing it all Together

Single Dwelling Examples

The following two examples illustrate how different single dwelling developments can achieve high quality design which are based upon the design process and considerations for this scale of development as detailed below

Example 1: Station Road, Tilbrook

This dwelling constitutes a replacement dwelling on the site within a country village.

The positive outcome to the site's development included:

- Retention of existing frontage hedgerows and trees.
- Development reflecting the built form of the area.
- Building incorporating sympathetic materials to the locality.
- Building containing variation of scale.
- Sympathetic garage building set well back from frontage.
- The use of architectural features that add interest and distinctiveness to the building including, balance, windows, porch,

chimneys, and soft landscaping and garden design.

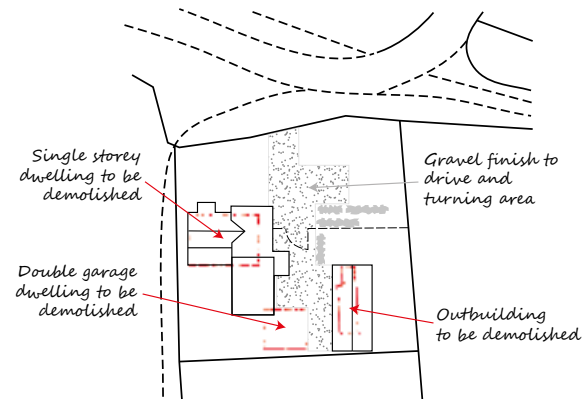

Single dwelling, Station Road, Tilbrook.



Station Road, Tilbrook





Feature frontage gable, variation in scale



Attractive soft landscaping and subservient garage



exposed brick chimney, variation in windows and exposed timber verge details





Example: 2 High Street, Yelling

The site is within a rural village, and in a Conservation Area and contains a significant number of mature trees. There is a notable fall in ground levels on the site.

This single dwelling was also approved as a replacement dwelling, but for a detached building on a relatively large plot where the previous building had burnt down.

Planning permission had been granted for four different schemes; in 2002, 2004, 2010 and 2013. All were considered acceptable at the time, and all had different attributes, albeit all being of similar scale.

This site is important in that it demonstrates that there are several ways of developing a site. In these four instances the following differing design approaches were taken:-

- A contemporary building with predominantly south facing glazing
- A thatched cottage
- A barn style building
- Another more contemporary building on the same footprint as the barn style building (the floor plate had already been

laid for the barn style building when this revised design was proposed)

The positive outcome to the site's development included:

- Retention of existing trees.
- Siting and finished floor level of the dwelling is notably lower than the street, working with the site topography and thereby minimising impacts from the street scene and adjacent trees.

- Low two storey building with mono pitch and flat roof forms incorporating a green roof.
- Strong contemporary architecture with variation in scale and interesting features crating distinctiveness to the building.
- Dwelling maximising solar gain and orientation of the site.
- Good use of landscaping to complement the design of the dwelling.



Single dwelling, High Street, Yelling







4.6 Scenario Four

Extensions and Alterations

Many buildings are likely to be extended or altered to meet residents and building use requirements. Not all extensions or alterations require planning permission, however this section will provide a useful guide to the principles to be considered when designing or considering any extension or alteration whether it needs permission or not.

Advice on extensions is detailed within section 3 of this Design guide. It is important any extension or alteration responds positively to the context of surrounding properties and buildings, the street and the wider environment in which development is taking place.

There are many opportunities for extensions to complement the character of the host building though either a traditional architectural form or contemporary interpretations. High quality design is important and must be considered in relation to the scale, mass, siting and materials of the extension and host building.



The Council is committed to improving the quality of design of residential extensions, alterations and redevelopments. Good design

respects the positive aspects of local character whilst seeking imaginative solutions to the issues of access for everyone, prevention of loss of privacy and daylight for neighbours.

The Council will need to consider any objections received from neighbours when assessing a planning application. Hence it is advisable to discuss the proposed development with any neighbour who might be affected, and to do so before detailed plans are drawn up and submitted for planning approval.

This section sets out how those drawing up such proposals should apply the place making principles and design objectives in order to achieve the necessary quality of design. The questions over the next few pages deal with the particular issues that are likely to occur on extensions or alterations. If addressed comprehensively they will enable developers, designers and consultants to bring forward schemes.

At the end of this section are two examples of development with constraints including conservation areas, tree preservation orders and topography.



Questions to consider

Extensions and Alterations

This section provides a series of questions relating to the design requirements for extensions and alterations that should be considered through the design process.

1. Site Context

- 1.1 Does the proposed extension or alteration demonstrate an understanding of the character and context of the host building and surrounding area?
- 1.2 Has consideration been given to existing features which could influence the design of the extension such as trees, nearby listed buildings, key views through the site, adjacent foundations and drains or soakaways?

- 1.3 Have potential impacts on / from neighbours / surrounding development been taken into account? (Impacts include loss of light and privacy, overlooking, loss of amenity space, noise and disturbance or overbearing impact).
- 1.4 Are extensions proportionate to the host building being extended and reflect its character in terms of scale and mass?

2. Landscape and Environment

- 2.1 Does the front extension provide a positive contribution to the character and appearance of the area, echoing the style of the house and neighbouring properties (such as materials and roof pitch)?
- 2.2 Has sustainable drainage been considered?

- 2.3 Have opportunities for biodiversity enhancement been considered?

3. Building Form

- 3.1 Does the extension create an attractive and high quality addition to the host building?
- 3.2 Has the proposal considered balance and harmony, and scale and mass?
- 3.3 Is the extension proportionate in size and not over dominating, and contribute positively to the character and appearance of the host building?
- 3.4 Are appropriate gaps between buildings retained to protect the street scene?



3.5 Is rear access to the property and parking provision retained?

6.2 Does the garage comply with sizes recommended within [section 3](#) of the Design Guide?

4. Dormer Windows

4.1 Are the dormer windows and/or roof extensions sympathetic within the street scene and any windows proportionate and centred on the windows below?

5. Annexes

5.1 Does the annex demonstrate clear connections with the main property and is it proportionate in scale and mass?

6. Garages

6.1 Is the garage subservient in terms of its location, scale and mass, and does it respect the character of the host dwelling?

B

H

←

→



Bringing it all Together

Extension Examples

The following examples illustrate how different extensions and styles can achieve high quality design which are based upon the design process and considerations for this scale of development as detailed below.

Example 1: Sandford House, St George Street, Huntingdon

This development brought back into use the former Post Office Building and Chapel, both listed buildings within the conservation area, with an extension linking them together to create a new pub and restaurant. There are many positive outcomes of the sites reuse, however in terms of the positive outcome to the new extension these include:

- Subservient extension in terms of scale, height and setback to both existing host buildings.
- Architecture incorporating semi curved windows and openings of the host buildings.
- Sympathetic use of building materials



Site plan of extension to form Sandford House, St George Street, Huntingdon.



View of extension from George Street

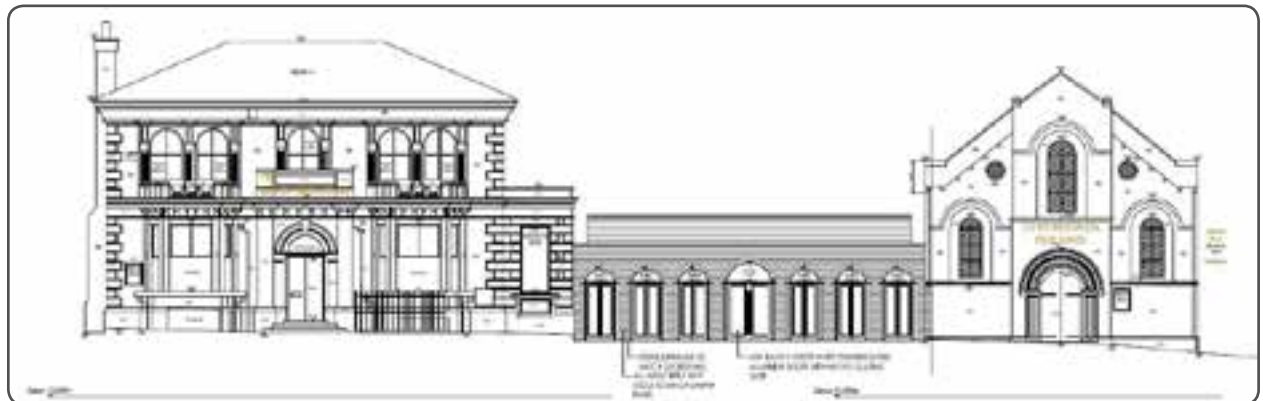

Front elevation of Sandford House, showing the extension linking the two old buildings





Example 2: High Street, Needingworth

This extension is a single storey side extension to the existing dwelling which is located back edge of pavement within the historic core of the village.

The positive outcomes of the new extension include:

- Subservient extension in terms of scale, height and setback to the existing host dwelling.
- Architecture incorporating contemporary triangular window feature within the apex of side gable wall.
- Sympathetic use of building materials to the host buildings.
- Extension location following and respecting bend within site frontage of the site.



Site plan of extension at High Street, Needingworth



Before



Proposed front and side elevations for extension at High Street, Needingworth



4.7 Scenario Five

Homes with care provision

This is a type of development that is becoming more common with an ageing population, and it is important that design principles for this type of land use are established.

New housing types are emerging to cater for this ageing population. They can variously be described as:-

Independent living

These are usually flats without a warden but with some communal facilities such as a lounge for residents, a small domestic kitchen for social events and an office for the housing manager. They are usually located in more urban areas.

Extra care sheltered housing

This is usually a corridor access apartment block with hotel style communal facilities on the ground floor. They are generally 1 bed but there is a trend to provide some 2 bed flats. Communal facilities generally include a lounge, a dining room, hairdressers, laundry and kitchen. These facilities are provided by the public sector and are increasingly being seen as community based facilities.

Assisted living

This is the term generally applied to the private sector equivalent of extra care sheltered housing.

Residential care and nursing homes

Under planning law this falls into institutional use rather than residential use. Care and nursing homes provide 24 hour care for their residents, with bedrooms generally grouped into wings or clusters sharing a range of facilities.

A 60 bed care home is regarded as a cost efficient operational unit. The need for intensive 24 hour care will not be addressed by an extra care facility.

Retirement village

This is a broad term for larger scale age restricted housing development, with social interaction promoted.

While there has been no significant change in these housing types over the past 20 years, there is a blurring between the types.

This section sets out how those drawing up such proposals should apply the place making principles and design objectives in order to achieve the necessary quality of design. The questions over the next few pages deal with the particular issues that are likely to occur on homes with care provision. If addressed comprehensively they will enable developers, designers and consultants to bring forward schemes.

At the end of this section are two examples of development with constraints including conservation areas, listed buildings, tree preservation orders and flood risk considerations.



Questions to consider

Homes with care provision

This section provides a series of questions relating to the design requirements for homes with care provision or similar developments that should be considered through the design process.

1. Developing the scheme

- 1.1 Has a step by step process been undertaken including a site appraisal and its setting and design evolution?

2. Site Context

- 2.1 Does the proposed development demonstrate an understanding of the character and context of the existing urban pattern i.e. the layout, nearby open spaces, trees, road and pavement widths, size and shape of buildings, boundary presence and landscape?

- 2.2 Has consideration been given to existing features which could influence the design, such as trees, nearby listed buildings and further away landmarks and vistas?

- 2.3 Have potential impacts on / from neighbours / surrounding development been taken into account? (Impacts include loss of light and privacy, overlooking, loss of amenity space, noise and disturbance or overbearing impact).

3. Land Use and Density

- 3.1 Is the proposed building density sympathetic to the adjacent densities of development?
- 3.2 Does the proposed density ensure that appropriate amenity levels and parking to serve the development can be met?

4. Access and Movement

- 4.1 Do proposals make use of existing access points?
- 4.1 If new access points are proposed are they convenient for future users of the site and neighbouring development?

5. Block Structure

- 5.1 Have any existing buildings of value been retained and included within the proposal, including listed buildings?
- 5.2 Does the proposed development / building and its location on site reflect the surrounding pattern, massing and density of development?



5.3 Does the development / building maximise street frontage and provide active frontage over the public realm?

6. Landscape & Public Realm

6.1 Has existing site features such as hedgerows, trees and boundary walls been retained and incorporated within the scheme?

6.2 Has the proposal considered the immediate public realm and how the site could improve it through tree and shrub planting, street furniture, public art or other landscaping

6.3 Does new planting assist in reinforcing local distinctiveness and is native planting appropriate?

6.4 Has sustainable drainage been included within the development?

6.5 Do hard surfaces incorporate high quality paving materials to create a high quality public realm?

7. Building Form

7.1 Does the building form create an attractive and high quality building / group of buildings?

7.2 Does the proposal take into consideration the location, setting and building mass of other development in the context of the site, streetscape and landscape?

7.3 Does the position of buildings make the most of the benefits of daylight and sunlight? Has there been a regard to micro-climate?

7.4 Has the proposal considered the following elements of building form?

- Balance and harmony
- Scale and massing
- Turning a corner
- Privacy and defensible space

8. Parking & Servicing

8.1 Has car parking for residents, visitors and staff been designed so as not to dominate the entrance to the site and its street frontage?

8.2 Has secure and sheltered cycle parking provision been provided in convenient locations?

8.3 Have all refuse and servicing requirements been addressed?





8.4 Is a range of parking solutions proposed and is it conveniently located for all uses on the site?

9. Details

9.1 Has a generic approach to development been avoided with every effort made to embrace the principles of local distinctiveness?

9.2 Does the architecture and building mass respond to the surrounding site context, including existing buildings or landscape character and have local building materials, details and colours been followed?

9.3 Have appropriate high quality boundary treatments been incorporated and have they taken into account the prevailing character of the area?

9.4 Has the following elements of building detailing been considered: Articulation, gable, roof, eaves and ridge lines, chimneys, utilities, doors, windows, balconies, hard and soft landscaping, thresholds, materials for the walls and roof, ecological enhancement.

(B)

(H)

(←)

(→)



Bringing it all Together

Homes with care provision

The following two examples illustrate how different homes with care provision developments can achieve high quality design which are based upon the design process and considerations for this scale of development as detailed below.

Example 1: Carysford Close, Elton

The development was built in 2007 and is opposite the church. The site is located within the conservation area and adjacent to a listed barn.

The positive outcome to the side's development included:

- Successful retention of historic frontage wall and prominent trees.
- Development successfully arranged as a courtyard with sympathetic density to the location and development.
- Frontage to main street.
- Development reflecting the built form, architecture and materials of the area.
- High quality public realm.
- Variation of scale throughout the site

reflecting the hierarchy of built form and residential uses across the site.

- Within walking / cycling distance to village centre.
- Single point of vehicular access and parking located towards the rear of the site in discrete locations.
- Development minimising impacts on adjacent Listed Building.
- Bin storage in convenient yet discrete locations.



Retirement dwellings, Carysford Close, Elton



Carysford Close, Elton





Shared garden



Street frontage



Pleasing relationship between buildings and landscaping



Soft golden gravel colour for shared surface





Example 2: Field Lodge, Hemingford Grey

Field Lodge is a care home that provides for nursing, residential, respite and dementia specialist care. The development was built on the site of a former motel and is surrounded by residential areas. The site is long and narrow, and contains tree preservation orders and in a flood risk area. The site is immediately adjacent to a listed building and a conservation area.

The positive outcome to the site's development included:

- Successful retention of TPO trees with building designed to respect their setting.
- Building floor level responding to flood risk issues and scale and height designed to minimise impact due to elevated floor levels and potential impacts on adjacent development.
- Development set back from the highway maintaining the established character of development along this part of the street, whilst providing an active frontage.
- Efficient use of the site incorporating, parking, servicing and amenity garden areas.

- Building mass broken down into different scales and architectural response, incorporating 2 storey at the front in materials of the area, with semi circular windows reflecting the adjacent listed building, with large built form and contemporary design at the rear.
- High quality public realm with the adjacent pavement to the front increased in width to accommodate a cycle path.
- Within walking / cycling distance to St Ives town centre for staff and visitors with dedicated cycle parking.
- Single point of vehicular access and parking located at the front and side with soft landscaping.
- Development form minimising impacts on adjacent Listed Building and conservation area.
- Bin storage in convenient yet discrete locations.





Use of large windows



Building respecting setting of mature tree



Variety in built form



Well detailed street frontage





4.8 Scenario Six

Commercial Development

This section provides guidance on the development of commercial buildings. These may be large and small in scale. This may encompass:

- Offices
- Industrial
- Warehousing
- Food stores and supermarkets
- Large-footprint retail units and warehouses
- Agricultural buildings
- Hotels
- Leisure and entertainment centres

Commercial buildings are typically large structures built using modern construction techniques and conventionally will be characterised by the following features:

- Large footprints built with wide roof spans
- Low-rise — typically single storeys (or 2-3 storeys if offices or up to 5 storeys if hotels)
- Horizontal elevations with flat or low pitched roofs

- Industrial buildings tend to consist of a large expanse of blank, cladded frontages, with limited windows
- In contrast offices and hotels will usually have lots of windows
- High levels of visibility required reflecting commercial requirements
- Free standing buildings, either single or in groups, set back from site boundaries
- Reliance on high levels of artificial lighting and mechanical heating/cooling
- Often require large amounts of surface car parking
- Often require servicing by heavy goods vehicles

These features are likely to lead to significant resource inefficiencies and high carbon emissions due to location, siting, layout, design, materials and accessibility. The sustainable design of commercial buildings presents significant challenges for planners and designers, particularly if such buildings are proposed in sensitive locations such as conservation areas or on the urban/rural fringe.

However, such buildings will play an important role in supporting economic growth and providing services to the existing and emerging local population. In accordance with Local Plan policies such buildings will be typically constructed within identified employment areas, existing town centres and new centres serving development.

This section sets out how those drawing up such proposals should apply the place making principles and design objectives in order to achieve the necessary quality of design. The questions over the next few pages deal with the particular issues that are likely to occur on commercial development. If addressed comprehensively they will enable developers, designers and consultants to bring forward schemes.

At the end of this section are four examples of different commercial developments with constraints including conservation areas, listed buildings, tree preservation orders and drainage considerations.



Questions to consider

Commercial Development

This section provides a series of questions relating to the design requirements for commercial or similar developments that should be considered through the design process.

1. Developing the scheme

- 1.1 Has a step by step process been undertaken including a site appraisal and its setting and design evolution?

2. Site Context

- 2.1 Does the proposed development demonstrate an understanding of the character and context of the existing urban pattern i.e. the layout, nearby open spaces, trees, road and pavement widths, size and shape of buildings, boundary presence and landscape?

- 2.2 Has consideration been given to existing features which could influence the design, such as trees, nearby listed buildings and further away landmarks and vistas?

- 2.3 Have potential impacts on / from neighbours / surrounding development been taken into account? (Impacts include loss of light and privacy, overlooking, loss of amenity space, noise and disturbance or overbearing impact)

3. Land Use and Density

- 3.1 Has the land use been identified based upon the site's setting and local requirements?

- 3.2 A Has the proposed development considered the potential for both horizontal mix of uses (in terms of adjacent uses within surrounding buildings) and vertical mix of uses (in terms of mix of uses within individual buildings)?

- 3.3 Have complimentary land uses been proposed? For example proposals for retail premises may be appropriately located with office, leisure or residential uses, particularly within town centres. In other instances, a single use may be appropriate, for example in industrial uses.

- 3.4 Are efficient plot ratios proposed that provides for appropriate amenity levels and parking to serve the development?



4. Access and Movement

- 4.1 Are commercial uses accessible from the primary street network?
- 4.2 If new access points are proposed are they convenient for future users of the site and neighbouring development?
- 4.3 Where new streets or spaces are proposed do they reflect the surrounding urban grain?
- 4.4 Has consideration been given to how routes through the proposed development can contribute to wider connectivity?
- 4.5 Has appropriate provision been made for accessibility by pedestrian and cyclists?
- 4.6 A Have existing public rights of way been accommodated?

5. Block Structure

- 5.1 Have any existing buildings of value been retained and included within the proposal, including listed buildings?
- 5.2 Does the proposed development / building and its location on site reflect the surrounding pattern and massing of development?
- 5.3 Do commercial buildings maximise street frontage, continuity and enclosure, and provide active frontage over the public realm?
- 5.4 Have “big box” activities (for example supermarkets, warehouses, cinemas) been integrated into their surroundings, for example by wrapping with active uses including small-scale commercial and residential activities?

- 5.5 Has consideration been given to appropriately located feature buildings and landmarks within the overall block structure?
- 5.6 Are large scale buildings sited to reflect context and topography?

6. Landscape and Public Realm

- 6.1 Has existing site features such as hedgerows, trees and boundary walls been retained and incorporated within the scheme?
- 6.2 Has the proposal considered the immediate public realm and how the site could improve it through tree planting, external lighting, street furniture, public art or other landscaping.
- 6.3 Does new planting assist in reinforcing local distinctiveness and is native planting appropriate?





- 6.4 Has sustainable drainage of the site and buildings been incorporated within the development?
- 6.5 Do hard surfaces incorporate high quality paving materials to create a high quality public realm?
- 6.6 Have outdoor spaces associated with commercial development such as external eating / gardens been designed to contribute to the public realm and provide a sympathetic interface?
- 6.7 Has consideration been given to appropriate visual and acoustic screening for servicing or external areas as appropriate?

7. Building Form

- 7.1 Do hard surfaces incorporate high quality paving materials to create a high quality public realm?

- 7.2 Does the proposal take into consideration the location, setting and building mass of other development in the context of the site, streetscape and landscape?
- 7.3 Has the proposal considered the following elements of building form?
 - Balance and harmony
 - Scale and massing
 - Roof form
 - Turning a corner
 - Privacy and defensible space.
- 7.4 Has the scale of commercial development been mitigated by appropriate facade treatment including the use of bays, columns and windows to breakup long frontages?

- 7.5 Do entrances and windows face onto the street to provide surveillance and activity?
- 7.6 Do the orientation of buildings maximise potential for daylight and natural ventilation?

8. Parking and Servicing

- 8.1 Has car parking for visitors and staff been designed so as not to dominate the entrance to the site and its street frontage?
- 8.2 Are parking areas considered as part of an overall landscape strategy for the site?
- 8.3 Has consideration been given to the use of multi-storey, decked or undercroft parking structures to maximise the use of land?





- 8.4 Is secure and sheltered cycle parking provision proposed in close proximity to main entrances?
- 8.5 Is servicing by HGVs proposed away from primary pedestrian and cycle routes and orientated away from any sensitive neighbouring uses?
- 8.6 Where on-street servicing is required do proposals demonstrate that the effects on other street users will be minimal?
- 8.7 Have all refuse and servicing requirements been addressed?

9. Details

- 9.1 Has a generic approach to development been avoided with every effort made to create a locally distinctive development?

- 9.2 Does the architecture and building mass respond to the surrounding site context, including existing buildings or landscape character and have local building materials, details and colours been followed?
- 9.3 If new access points are proposed are they convenient for future users of the site and neighbouring development?
- 9.4 Has the following elements of building detailing been considered: Articulation, gable, roof, eaves and ridge lines, chimneys / ventilation stacks, utilities, doors, windows, balconies, hard and soft landscaping, thresholds, materials for the walls and roof, ecological enhancement?

- 9.5 Has all external plant such as air conditioning, flues and ventilation been designed from the outset and located in accessible yet discrete locations?

10. Infrastructure

- 10.1 Has an appropriate phasing and construction strategy been produced that coordinates with the provision of infrastructure delivery?



Bringing it all Together

Example: Commercial Development Examples

The following 4 examples illustrate how different commercial development proposals can achieve high quality design solutions that are based upon the design process and considerations for this type of development as detailed below.

Example 1: Sandford House, St George Street, Huntingdon

This development that brought back into use the former Post Office Building and Chapel to create a new pub and restaurant, used as an example in Scenario Four, [please add link] also included a 22 room hotel. The development is a partial rebuild of the old sorting office to the rear of the main post office building.

The positive outcomes of this development include:

- Scale and mass reduced compared with the original sorting office building gives a more sympathetic relationship with the listed buildings.
- Design seeks to minimise impact on neighbouring buildings including adjacent

residential properties to the northeast through careful consideration of the placement of windows, extractors and other details.

- Sympathetic selection and use of building materials; timber cladding, slate roofing and rendered walls provides a strong contrast with the listed buildings.
- Car free development, with only taxi drop off.
- Within walking distance to town centre, railway station and bus station.

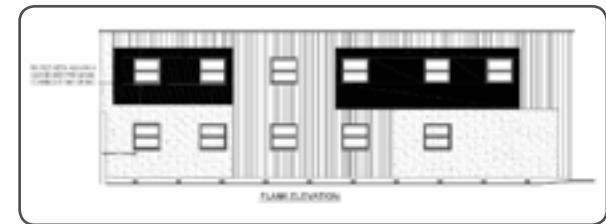
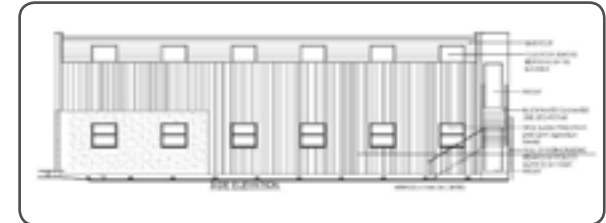

Site plan of hotel at Sandford House, St George Street, Huntingdon





Example 2: Eagle Business Park, Yaxley

This business park to the northeast of Yaxley is a site allocated in the Local Plan 1995. It provides business accommodation in various building sizes for a wide range of 'B' and sui generis employment uses. It is a good example of consistency of design being maintained over the whole site. The 2001 outline application for the site required the submission of a development brief as part of the conditions for the application. The brief addressed the following:- design statement, a visual appraisal, site features to be preserved, footpath alignments and links, provision for cyclists, green travel principles, types of buildings their form and orientation, crime reduction measures, noise reduction measures, the promotion of energy efficiency, principles of landscaping including planting of shelter belts at an early stage of the development and drainage. The approved development brief was used to form the basis of reserved matters applications and has been successful in its implementation and enabled straightforward planning application process on individual plots.



Areas for improvement would be consistency with the size and positioning of signage for each unit and stronger soft landscaping.

The positive outcomes of the development include:

- Uniformity of building design style and quality throughout the business park.
- Consistent use of a limited range of materials and colours which provides identity to the business park.
- Early engagement with the Middle Level Commissioners meant that drainage issues were resolved in a straightforward manner.
- Good provision of cycle storage for the individual units.



Location plan of Eagle Business Park, Yaxley



Eagle Business Park, Yaxley



Aerial view of Eagle Business Park, Yaxley





Example 3: The Rowley Arts Centre, St Neots



The Rowley Arts Centre, St Neots - Site Location Plan

The development of this site began in 2004, following the production of a document for the District Council by The Civic Trust, that studied the future of St Neots Town Centre. It recommended several ways forward in redeveloping parts of the town, particularly responding to the way that housing and population growth has outstripped the provision of community facilities. It highlighted this part of the centre of St Neots as a potential development site, with the opportunity to create extra car parking, together with the potential to create attractive pedestrian linkages to the rest of the town centre.



Following from the outcomes of this document, the District Council produced a Development Brief for the site, which comprised of several different landowners and included the Old Fire Station Site along with the former household recycling centre and a public car park that lies to the east of the town centre. The objectives were to re-integrate this blocked off part of the town with the rest of St Neots town centre, to expand the footprint of the town centre, and to provide clear guidance to allow this to happen. The production of the document in 2009 provided a catalyst for a developer to see the potential of this site and a niche in the market for leisure uses within the town. The District Council worked closely with the developer in producing guidance for the site based upon a cinema led development.

The Rowley Arts Centre is a mixed use scheme providing a 6 screen cinema, four restaurants with external seating area, 3 flats and a public space. The site is within a mixed use area including a supermarket and adjacent to a residential street, within the conservation area and adjacent to a listed building. There are several notable trees on site.

The positive outcomes of the development include:

- Successful redevelopment of a collection of parcels of land with constrained access.
- Scale, mass and positioning of the building(s) responding to adjacent land uses.
- A mix of contemporary architecture including more traditional forms used for the restaurant building adjacent to listed building at the western side of the site with less conventional details on the cinema building itself.
- Good use of a limited palette of materials gives a cohesive feel to the development and is sympathetic to the character of this part of St Neots.
- Successful retention of important site trees and new feature tree.
- High quality public realm space and pedestrian routes into the site.
- Provision of cycle parking.
- Within walking and cycling to other town centre amenities.
- Provision of car park to the rear.



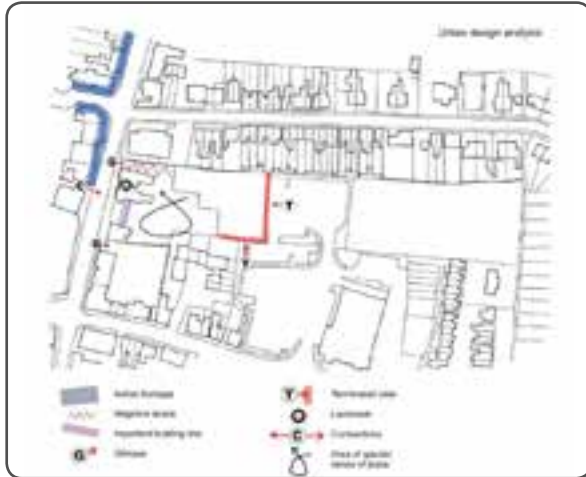

2009 Development Brief for The Old Fire Station Site, St Neots - Urban Design Analysis Plan of the site



Two of the new contemporary restaurant units, low scale and form, in conjunction with existing traditional listed building adjacent, The Rowley Arts Centre, St Neots



Retained trees in the development and pedestrian route through to the cinema, The Rowley Arts Centre, St Neots



Contemporary design echoing built form of adjacent listed building, mixed use with commercial at ground floor and residential above sited on back edge of footpath, The Rowley Arts Centre, St Neots.



Pedestrian route to from Huntingdon Street to restaurants and cinema, active surveillance of the route and attractive public realm, The Rowley Arts Centre, St Neots



Scale and mass of the cinema building broken up through use of subtle variation in height, undulation on external cladding and different use of materials and colours, Rowley Arts Centre, St Neots





Example 4: Supermarket, Huntingdon

This supermarket was a redevelopment of a bus depot and maintenance garage and four residential properties on the south side of Ermine Street in Huntingdon. The site lies between the embankment of the east coast mainline railway and a recent residential redevelopment. Additionally the site contains a protected tree.

The original development proposal was won on appeal for the demolition of existing buildings and erection of a foodstore and 14 apartments (for social rent). The appeal established the principle of retail development at this out of centre location. Subsequently a further application for a supermarket, omitting the residential part of the earlier scheme was submitted. The Council worked closely with the

applicant on the details of the second proposal to ensure that a successful development was achieved.

The positive outcomes of the new extension include:

- Location of building close to the footpath of Ermine Street provides active frontage to the main street and turns the corner into the site.
- Good use of contemporary design and materials.
- Building scale, mass and layout is sympathetic to adjacent residential properties.
- Car parking layout includes protected tree.
- Within walking / cycling distance to surrounding residential areas.



Location plan of supermarket, Ermine Street, Huntingdon



Front elevation, supermarket, Ermine Street, Huntingdon

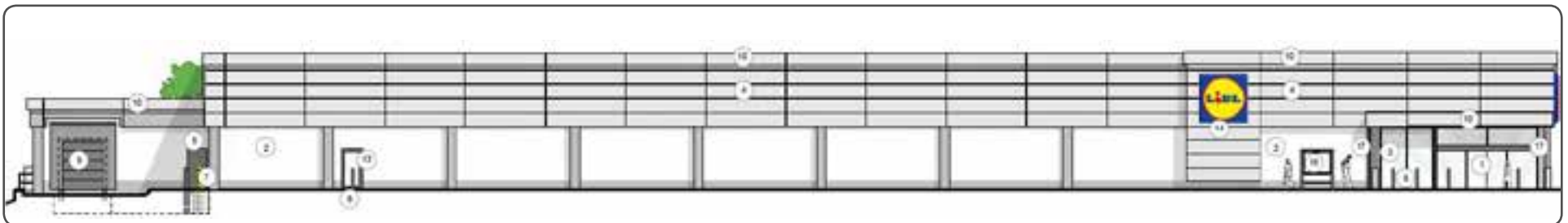

Side elevation, supermarket, Ermine Street, Huntingdon





Photographs of Supermarket , Ermine Street, Huntingdon on this page:

Top right, Active frontage successfully turns the corner and addresses main road frontage and car parking area.

Top left: Active frontage to Ermine street

Bottom: Parking area gives space for protected tree, Supermarket, Ermine Street, Huntingdon.

References and
further reading.
Policy and
Regulations.

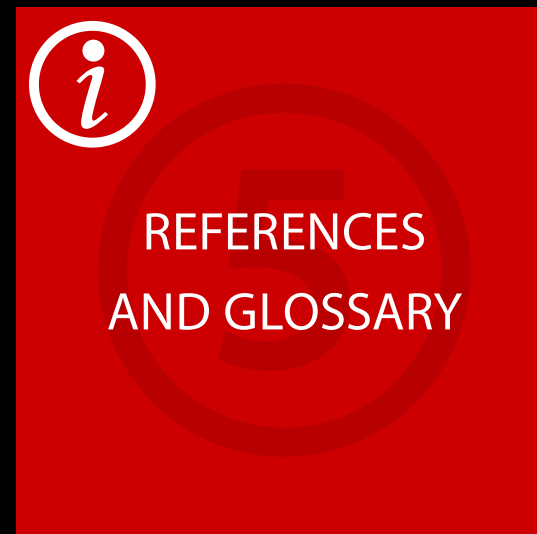



5.1 References and Further Reading

Web Resources

1. *National Planning Policy Framework*
2. *National Planning Policy Guidance*
3. *Building Regulations*
4. *Sustainable building design (BREEAM)*
5. *Manual for Streets*
6. *Development in historic areas*
7. *Urban Design Compendium*
8. *Sustainable Drainage Systems*
9. *RUDI (Resource for Urban Design Information)*

The Development Plan

- Huntingdonshire Local Plan to 2036 (Draft)
Huntingdonshire Local Plan (1995)
Huntingdonshire Local Plan Alteration (2002)
Huntingdonshire Core Strategy (2009)
Huntingdon West Area Action Plan (2011)
- B** Cambridgeshire and Peterborough Minerals and Waste Core Strategy (2011)
- H** Cambridgeshire and Peterborough Minerals and Waste Site Specific Proposals (2012)
- ←**

Supplementary Planning Documents (SPD)

- Wind Energy Development in Huntingdonshire SPD (2014)
Developer Contributions SPD (2011)
Huntingdonshire Landscape and Townscape Assessment SPD (2007)

Other documents and sources

- Bentley, I. et al (1985) *Responsive Environments*. Oxford: Architectural Press.
- Barton, H., M. Grant & R. Guise (2010) *Shaping Neighbourhoods*. 2nd Edition. Abingdon: Routledge
- English Partnerships/Urban Villages Forum (1998) *Making Places*. London: English Partnerships/Urban Villages Forum.
- The Princes Foundation (2003) *Urban Villages and the Making of Communities*. London: Spon Press
- Urban Design Group (2002) *Urban Design Guidance*. London: Thomas Telford.
- Urban Villages Group, (1992) *Urban Villages*. London: Urban Villages Group.

Types of design guidance

There are two main types of guidance:

Guidance relating to specific places - There are three main types of these: urban design frameworks for areas; development briefs and master plans for sites.

Guidance relating to specific topics - These may cover topics such as shop fronts, house extensions or lighting.

Place specific guidance:

Urban design Frameworks - An urban design framework (UDF) is a document describing and illustrating how planning and design policies and principles can be implemented in an area where there is a need to control, guide or promote change. UDFs are often drawn up for areas such as urban quarters, transport interchanges, regeneration areas, town centres, urban extensions and new settlements.

An area may be one that is likely to be developed in several phases and by several different developers. UDFs can be used to coordinate more detailed development briefs and master plans.





Development briefs - A development brief provides guidance on how a specific site can be successfully designed in line with the relevant planning and design policies. It will usually contain some indicative but flexible vision of the form future development should take.

The terms 'planning brief' or 'design brief' are sometimes used, but generally refer to the same type of document.

Master plans - A master plan explains how a site or series of sites will be developed. It describes how the proposals will be implemented, and sets out the costs, phasing and timing of development.

The purpose of the master plan is to set out the principles of matters of importance, not to prescribe in detail how development should be designed.

Design code - A design code is a document that sets rules for the design of a new development. It sets out the design parameters and standards which have been established through a UDF, Development Brief or Master plan process; the UDF or master plan or framework provides the vision, while the design code defines the scope and characteristics for the more detailed design.

It should be based on a clear design rationale followed by a code that gives instructions to the appropriate degree or precision.

B

H

←

→



GLOSSARY

→ A

archaeological assessment/evaluation

: a) desk-based assessment of the known or potential archaeological resource within a specified area or site on land or underwater; b) field evaluation of non-intrusive and/or intrusive fieldwork which determines the presence or absence of archaeological features, structures, deposits, artefacts, or ecofacts within a specific area or site on land or underwater.

ashlar : finely finished blocks of stone masonry laid in horizontal courses with vertical joints, creating a smooth formal effect.

→ B

“biodiversity” : all aspects of biological diversity.

building line : extent of building frontages at the edge of a block or site.

→ C

cambridgeshire peg tiles : buff and pastel shaded Gault-clay plain tiles, traditionally fixed using timber pegs.

carstone : mid to dark brown sandstone (also known as ironstone) of rather irregular shape and quality.

cill : horizontal base of window-opening or door-frame, usually timber or stone.

cobbles : small rounded stone used for paving and building.

collyweston slates : limestone slates quarried in the north west of the District

conservation area : a formally designated area of special architectural or historic interest, the character or appearance of which it is desirable to preserve or enhance.

contour plan : plan indicating contour lines.

corbel : projection of stone, timber etc. jutting out from a wall.

cornice : ornamental projecting moulding at the top of a building, wall or shop front.

county wildlife site : a site identified by the Wildlife Trust for Bedfordshire, Cambridgeshire, Northamptonshire and Peterborough as being of particular local value for wildlife.

coursing : continuous horizontal layer of masonry (such as brick or coursed stone).





GLOSSARY

→ D

dentil course : projecting and indented course of brickwork at the eaves, carrying gutter. Various patterns are created by different laying techniques.

design code : document setting out detailed principles to be applied to particular aspects of a scheme's design.

design and access statement (DAS): statement to be submitted with a planning application describing and explaining the design and access principles employed.

development brief : document containing general guidance on how a site is to be developed, in the context of relevant planning and design policies.

development plan : a term used to describe collectively the statutory plans for an area.

door surround : timber assembly around door, usually based on the classical motif of column, frieze and cornice.

→ E

embodied energy : the energy consumed in producing, transporting and using materials.

enclosure : definition of space or area.

environmental impact assessment (EIA) : the process of identifying, describing and assessing the potential effects of a project upon the environment. For certain types of project an EIA is a statutory requirement.

environmental statement : the report of an environmental impact assessment; i.e. the document that is required to be submitted to the local planning authority in appropriate cases.

→ F

façade : the front or face of a building.

fascia : a) a flat board, usually of wood, covering the ends of rafters. b) a plain strip with name etc. over a shop front.

flue : smoke duct in chimney.





GLOSSARY

→ **G**

gable : triangular upper part of a wall at the end of a ridged roof.

gault clay : clay producing buff and pastel shaded hues, used for bricks and roof tiles.

Green infrastructure : A network of multi-functional green space, urban and rural, which is capable of delivering a wide range of environmental and quality of life benefits for local communities.

→ **H**

Heritage asset : A building, monument, site, place, area or landscape identified as having a degree of significance meriting consideration in planning decisions, because of its heritage interest. Heritage asset includes designated heritage assets (world heritage sites, scheduled monuments, listed buildings, protected wreck sites, registered parks and gardens, registered battlefields or conservation areas) and assets identified by the local planning authority (including local listing).

→ **L**

Large scale development : for dwellings, a large scale development is one where the

number of residential units to be constructed is 50 or more. Where the number of residential units to be constructed is not given in the application a site area of 2 hectares or more should be used as the definition of a large scale development. For all other uses a large scale development is one where the floor space to be built is 2,500m² or more, or where the site area is 2 hectares or more.

Large scale major development : for dwellings, a large scale major development is one where the number of residential units to be constructed is 200 or more. Where the number of residential units to be constructed is not given in the application a site area of 4 hectares or more should be used as the definition of a large scale major development. For all other uses a large scale major development is one where the floor space to be built is 10,000m² or more, or where the site area is 2 hectares or more.

lintel : horizontal beam of timber, stone, etc. bridging an opening - usually across the top of a door or window.

listed building : a building or structure identified by the Secretary of State for Culture, Media & Sport as being of special architectural





GLOSSARY

or historic interest. There are three categories of listing: Grade 1 (the highest quality), Grade II* and Grade II.

local distinctiveness : the essential character of a locality.

→ M

mansard roof : roof with a double slope to each roof plane, the lower being steeper than the upper.

material considerations : considerations that must be taken into account when planning decisions are being made.

mortar : mixture of lime, cement, sand and water, for bonding bricks or stones.

→ O

overshadowing : permanent shading caused by adjacent development.

→ P

pantile : roofing tile of curved S-shaped or corrugated section.

permeability : a) the extent to which the built environment allows ease of access from place

to place though the number, convenience and visibility of routes through the urban fabric.
b) the degree to which a landscape surface (whether 'hard' or 'soft') permits water to pass through it.

Perforate garage doors : Allows natural ventilation and light into the garage whilst maintaining security. As the contents of the garage are visible from the street it encourages the occupant to use the garage for its intended purpose – car parking as opposed to storage. This is particularly important where the garage forms the only parking provision for the dwelling

pilasters : rectangular column projecting slightly from a wall.

plinth : the projecting base of a wall or column, generally angled at the top.

plot ratio: the proportion of a site occupied by buildings

purlin timbers : structural roof timber running along the line of the roof, which supports the rafters.





R → T

GLOSSARY

→ R

render : to cover a material (stone or brick) with a coat of plaster.

reveal : the exposed wall structure exposed by setting-back the window/door joinery from the face of the building.

roof pitch : angle at which rafters form an apex from the supporting walls.

roofscape : view resulting from a blend of roof pitches, sizes and heights within the built environment.

→ S

screen planting : planting to conceal development.

segmental arch : a curved arch above an opening constructed from shaped bricks or stones.

site appraisal : annotated drawing illustrating the physical constraints and opportunities that may affect a site's development.

site of special scientific interest (SSSI): a statutory designation applied to sites of particular wildlife and/or geological value.

soffit : the projecting underside of the eaves of a roof.

streetscape : the overall effect of street facades and linked spaces of a town or village.

street elevation : linear elevation showing a series of adjacent properties along a street.

string course : horizontal, usually projecting course of brickwork or stone across the facade of a building.

supplementary planning guidance (SPG) : guidance which supplements policies contained in the development plan.

sustainable drainage systems (SUDS) : techniques to control surface water infiltration and run-off in a manner that mimics natural systems.

→ T

townscape : the physical form and character of part of a built-up area.

tracking : the technique of fitting roads into the spaces enclosed by an arrangement of buildings (as opposed to arranging buildings around the layout of roads).





GLOSSARY

traffic calming : measures to moderate the volume, speed and behaviour of traffic in order to reduce adverse effects on road safety and the living environment.

transport assessment: an assessment of the potential transportation impacts of a development proposal

travel plan : a strategy for promoting sustainable (non-car) modes of access to and from a site.

tree preservation order (TPO) : an order made and confirmed by a local planning authority to protect trees from lopping, topping or felling without prior written consent.

→ U

urban design framework : document containing strategic guidance indicating how an area undergoing change is to be developed, in the context of relevant planning and design policies.

urban grain : the texture of a settlement (or part of a settlement), influenced by block size, street layout and the arrangement of plots and buildings.

→ V

verge : a) grass edging of a road b) junction between a roof and gable vernacular : relating to a native or local style, not foreign or formal.

vernacular: relating to a native or local style, not foreign or formal

vista: long narrow views framed between trees or built units, usually ending in a focal point

visual impact assessment : description and analysis of the potential visual impact of a development proposal.

→ W

weatherboarding : wedge-shaped overlapping horizontal boards used to clad a timber framed wall.

